

Lantech

T(P)ES-0105T 5 10/100TX (PoE at/af) + 1 10/100/1000T Unmanaged Ethernet Switch

User Manual



V1.04

Oct. 2025

RP-001-31

Notice

The unmanaged PoE Ethernet switch is equipped with P.S.E capacity. It is designed for data communication within vehicles, to facilitate data transfer and Ethernet connectivity as well as expandability. It's important to note that these features have no impact on the safety of driving and passenger well-being and the device does not possess any immunity-related functionalities.

Approval Information

Version 1.04	Name	Title	Date
Author	Alice Huang	Marketing	2025.10.28
Verifier	Jacky Chou	HW QA	2025.10.28
Approver	Thomas Lee	RD head	2025.10.28

Version	Date	Content of Modification	Author(s)
V1.00	2023.09.06		Greg Tsai
V1.01	2024.06.27	Update the ignition content.	Greg Tsai
V1.02	2024.10.22	Update the ignition content.	Greg Tsai
V1.03	2024.12.13	Update the ignition content.	Greg Tsai
V1.04	2025.10.28	Added unit conversion to torque guideline: 14 kgf·cm \approx 1.4 N·m.	Alice Huang

Recommendation for Shielded network cables

STP cables have additional shielding material that is used to reduce external interference. The shield also reduces the emission at any point in the path of the cable. Our recommendation is to deploy an STP network cable in demanding electrical environments. Examples of demanding indoor environments are where the network cable is located in parallel with electrical mains supply cables or where large inductive loads such as motors or contactors are in close vicinity to the camera or its cable. It is also mandatory to use an STP cable where the power device (like IP camera) is used outdoors or where the network cable is routed outdoors.

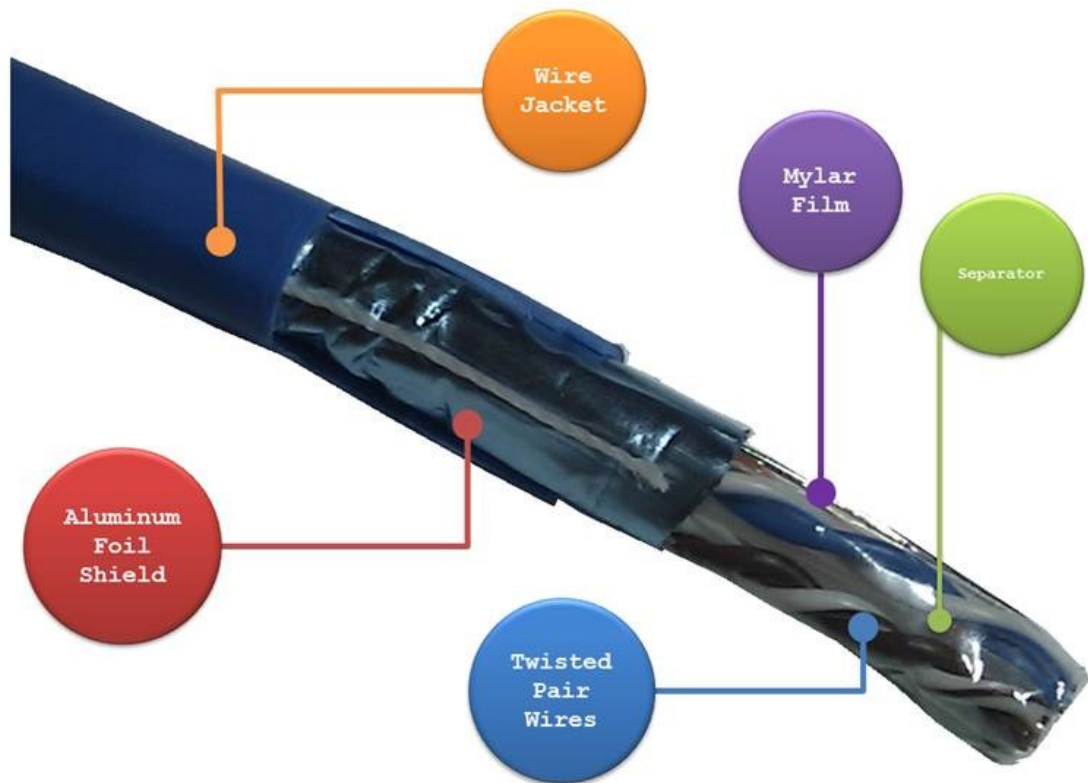

Important Notice

Lantech Communications Global, Inc. reserves the right to modify the equipment, its specification or this manual without prior notice, in the interest of improving performance, reliability, or servicing. At the time of publication all data is correct for the operation of the equipment at the voltage and/or temperature referred to. Performance data indicates typical values related to the particular product.

No part of this documentation or information supplied may be divulged to any third party without the express written consent of Lantech Communications Global Inc. Products offered may contain software which is proprietary to Lantech Communications Global Inc. The offer or supply of these products and services does not include or infer any transfer of ownership.

Interference Issues

This Equipment has been tested and found to comply with the limits for a Class A digital device, pursuant to Part 15 of the FCC rules. These limits are designed to provide reasonable protection against harmful interference in a commercial or industrial installation. This equipment generates, uses, and can radiate radio frequency energy. It may cause harmful interference to radio communications if the equipment is not installed and used in accordance with the instructions.

FCC Warning

This Equipment has been tested and found to comply with the limits for a Class-A digital device, pursuant to Part 15 of the FCC rules. These limits are designed to provide reasonable protection against harmful interference in a residential installation. This equipment generates, uses, and can radiate radio frequency energy. It may cause harmful interference to radio communications if the equipment is not installed and used in accordance with the instructions. However, there is no guarantee that interference will not occur in a particular installation. If this equipment does cause harmful interference to radio or television reception, which can be determined by turning the equipment off and on, the user is encouraged to try to correct the interference by one or more of the following measures:

- Reorient or relocate the receiving antenna.
- Increase the separation between the equipment and receiver.
- Connect the equipment into an outlet on a circuit different from that to which the receiver is connected.
- Consult the dealer or an experienced radio/TV technician for help.

CE Mark Warning

This is a Class-A product. In a domestic environment this product may cause radio interference in which case the user may be required to take adequate measures.

Content

Chapter 1 Introduction.....	6
Chapter 2 Hardware Description	7
2.1 Physical Dimension.....	7
2.2 Package Content:.....	7
2.3 IP Protection.....	8
2.4 Front Panel.....	11
2.5 LED Indicators.....	11
Chapter 3 Hardware Installation	13
3.1 Wall mount installation	13
Chapter 4 Connect Cable	16
4.1 Power input M12 connector.	16
4.2 Ignition and PoE off timer	20
4.2 10/100TX interface M12 connector	21
4.3 10/100/1000T interface M12 connector	23
4.4 Ground interface M6 connector	24

Chapter 1 Introduction

Lantech T(P)ES-0105T is a 5 10/100TX (PoE at/af) + 1 10/100/1000T M12-connector unmanaged industrial switches for IP44 rated protection, which meet the high reliability requirements demanded by industrial applications.

Chapter 2 Hardware Description

In this paragraph, it will describe the Industrial switch's hardware spec, port, cabling information, and wiring installation.

2.1 Physical Dimension

Aluminum case. IP-44, 175 mm (W) x 75.5 mm (H) x 90 mm (D)

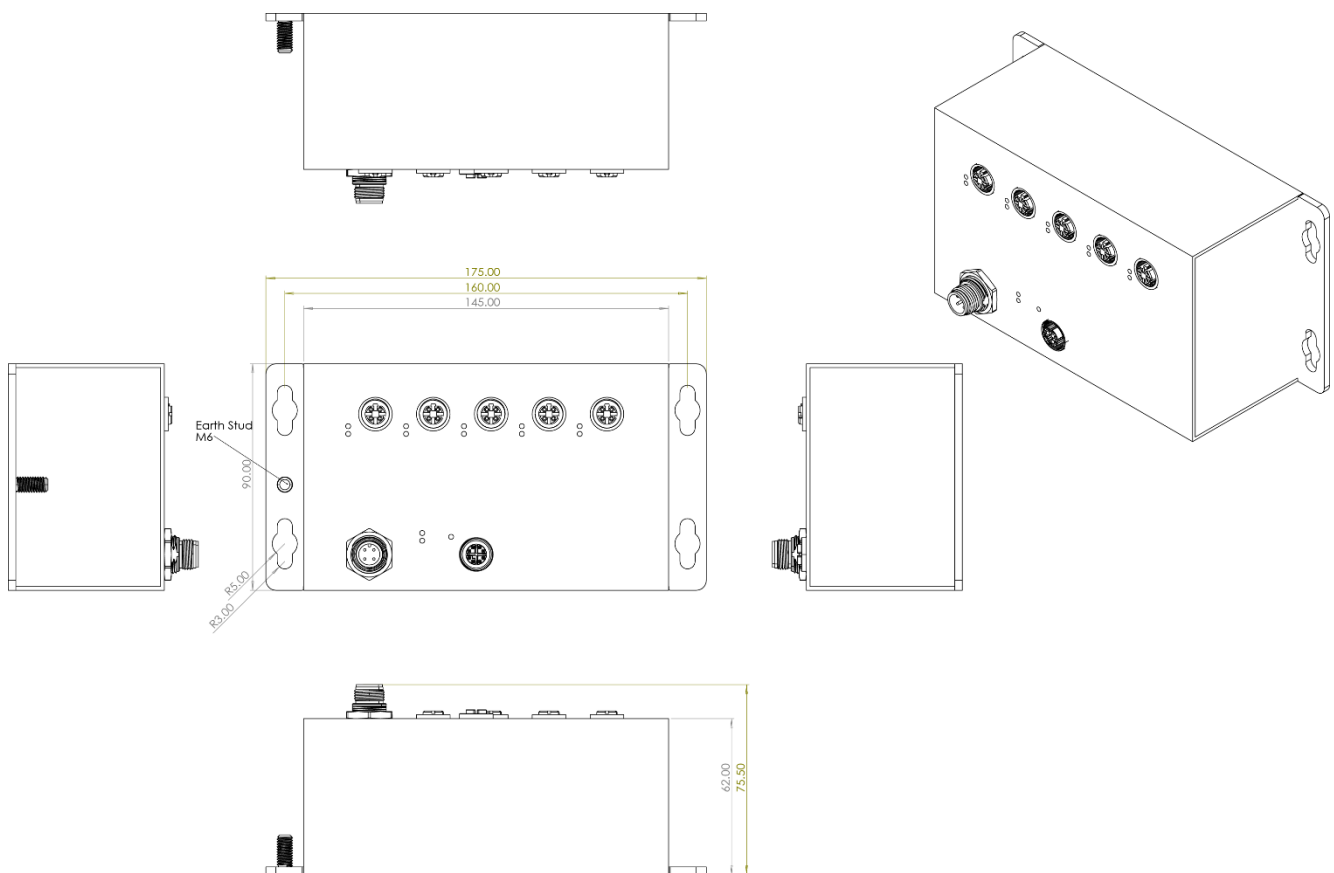

2.2 Package Content:

- Ethernet Switch
- Manual CD*

*By request

2.3 IP Protection

The **IP Code, Ingress Protection Rating**, sometimes also interpreted as **International Protection Rating**, classifies and rates the degree of protection provided against the intrusion (including body parts such as hands and fingers), dust, accidental contact, and water in *mechanical casings* and with electrical enclosures. It is published by the International Electrotechnical Commission (IEC)

Solid particle protection

The first digit indicates the level of protection that the enclosure provides against access to hazardous parts (e.g., electrical conductors, moving parts) and the ingress of solid foreign objects.

Level	Object size protected against	Effective against
0	—	No protection against contact and ingress of objects
1	>50 mm	Any large surface of the body, such as the back of a hand, but no protection against deliberate contact with a body part
2	>12.5 mm	Fingers or similar objects
3	>2.5 mm	Tools, thick wires, etc.
4	>1 mm	Most wires, screws, etc.
5	Dust protected	Ingress of dust is not entirely prevented, but it must not enter in sufficient quantity to interfere with the satisfactory operation of the equipment; complete protection against contact
6	Dust tight	No ingress of dust; complete protection against contact

Liquid ingress protection

The second digit indicates the level of protection that the enclosure provides against harmful ingress of water.

Level	Protected against	Testing for	Details
0	Not protected	—	—
1	Dripping water	Dripping water (vertically falling drops) shall have no harmful effect.	Test duration: 10 minutes Water equivalent to 1 mm rainfall per minute
2	Dripping water when tilted up to 15°	Vertically dripping water shall have no harmful effect when the enclosure is tilted at an angle up to 15° from its normal position.	Test duration: 10 minutes Water equivalent to 3 mm rainfall per minute
3	Spraying water	Water falling as a spray at any angle up to 60° from the vertical shall have no harmful effect.	Test duration: 5 minutes Water volume: 0.7 litres per minute Pressure: 80–100 kPa
4	Splashing of water	Water splashing against the enclosure from any direction shall have no harmful effect.	Test duration: 5 minutes Water volume: 10 litres per minute Pressure: 80–100 kPa
5	Water jets	Water projected by a nozzle (6.3 mm) against enclosure from any direction shall have no harmful effects.	Test duration: at least 15 minutes Water volume: 12.5 litres per minute Pressure: 30 kPa at distance of 3 m

6	Powerful water jets	Water projected in powerful jets (12.5 mm nozzle) against the enclosure from any direction shall have no harmful effects.	Test duration: at least 3 minutes Water volume: 100 litres per minute Pressure: 100 kPa at distance of 3 m
7	Immersion up to 1 m	Ingress of water in harmful quantity shall not be possible when the enclosure is immersed in water under defined conditions of pressure and time (up to 1 m of submersion).	Test duration: 30 minutes Immersion at depth of at least 1 m measured at bottom of device, and at least 15 cm measured at top of device
8	Immersion beyond 1 m	The equipment is suitable for continuous immersion in water under conditions which shall be specified by the manufacturer. Normally, this will mean that the equipment is hermetically sealed. However, with certain types of equipment, it can mean that water can enter but only in such a manner that it produces no harmful effects.	Test duration: continuous immersion in water Depth specified by manufacturer
9	Powerful high temperature water jets	Protected against close-range high pressure, high temperature spray downs.	—

2.4 Front Panel

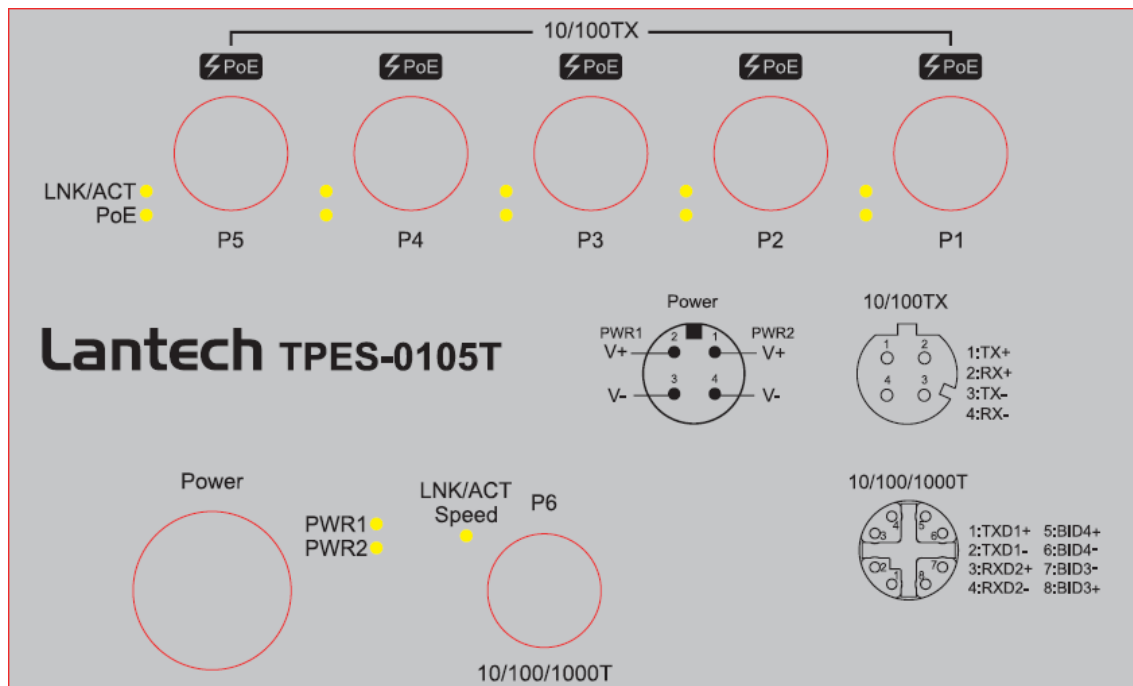

2.5 LED Indicators

The diagnostic LEDs that provide real-time information of system and optional status are located on the front panel of the industrial switch. The following table provides the description of the LED status and their meanings for the switch.

LED	Color	Status	Meaning
PWR1	Green	On	Power 1 is active
		Off	Power 1 is inactive
PWR2	Green	On	Power 2 is active
		Off	Power 2 is inactive
P1~P5 LNK/ACT	Green	On	A network device is detected.
		Blinking	The port is transmitting or receiving packets from the TX device.
		Off	No device attached

P1~P5 PoE (PoE model)	Green	On	The port is operating in PoE mode.
		Off	The port is not operating in PoE mode.
P6 LNK/ACT Speed	Green / Orange	Green	A network device is detected.
		Blinking	The port is transmitting or receiving packets from the TX device.
		Orange	Connected to network at speed of 1000Mbps

Chapter 3 Hardware Installation

There are no mechanically active moving parts in the switch, to fix the switch into an installation position, please use M4 size screw and corresponding nut and standard M4 screwdriver to install switch in the field.

3.1 Wall mount installation

Please make sure the screw diameter is M4.

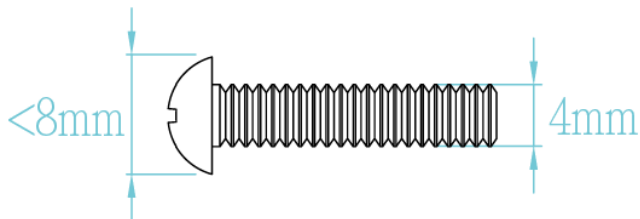

Check all 4 fix holes on the switch and find corresponding position in the wall .Use the appropriate tool to drill 4 holes onto the corresponding position, make sure the diameter of holes is compatible with the M4 screws, fix the 4 screws into these 4 holes but don't screw tightly, in order to have enough space to mount the switch.

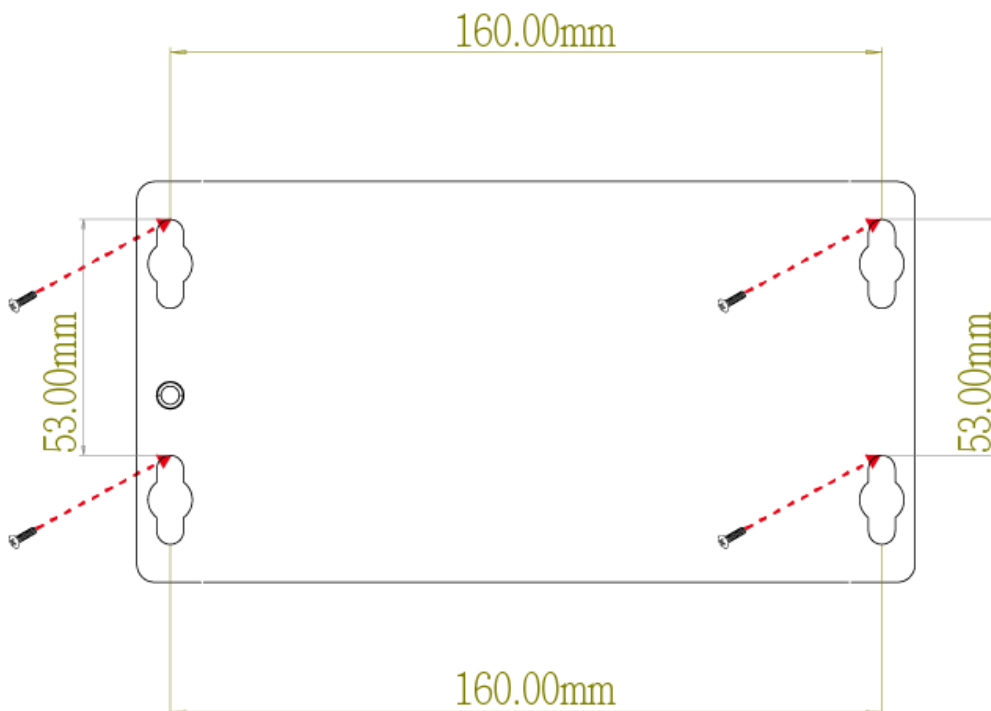

Mount switch in wall with 4 fixed screws.

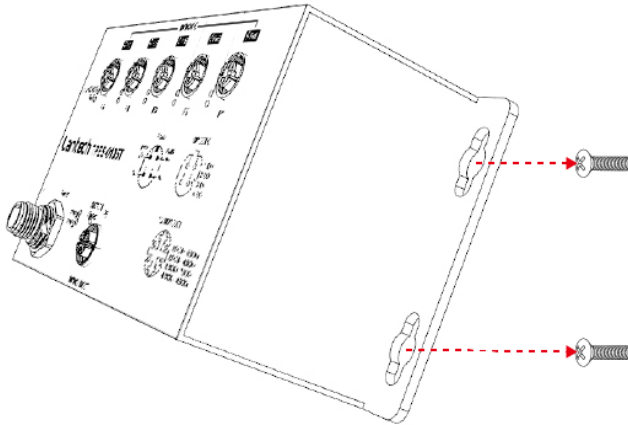

Attach switch in wall with 4 screws

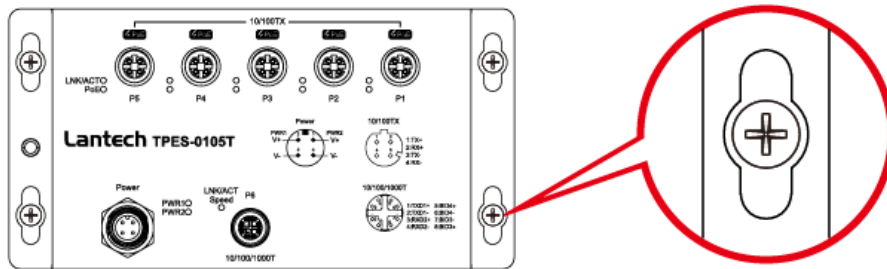

Move down

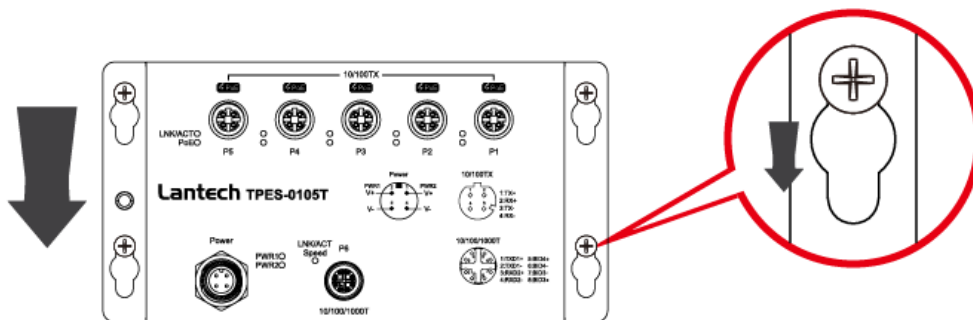

Tighten 4 screws

Chapter 4 Connect Cable

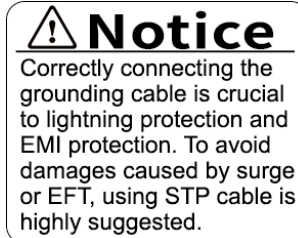

After the hardware installation is complete, please connect the cable to the switch. All the external interfaces use M12 connector design and follow IEC 61076 standard.

4.1 Power input M12 connector.

Note: Please check the power connector has been connected to the switch correctly before you turn on the power resource.

Spec. of power input

- Voltage of Power Input:
Dual DC input, 9VDC~36VDC
- Total PoE budget: 55W@24VDC (PoE model)
Please make sure that the external power supply unit can satisfy the total power consumption in field.

Note: The switch provides PoE budget up to 55W, if power overloads and exceeds 55W, it will stop supply PoE power, PoE LED will keep flashing and enter protection (hiccup) mode. (PoE model)

- Pin assignment of power input

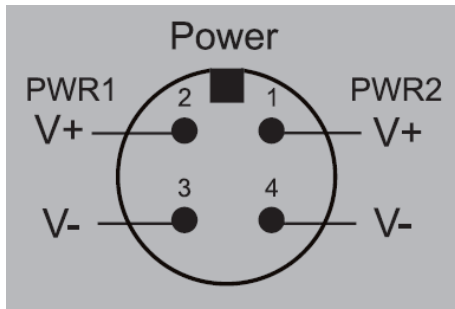

- Pin assignment of optional power cable ECONM12-4P(F)1.5M

PWR1 V+	•—————•	RED
PWR1 V-	•—————•	BLACK
PWR2 V-	•—————•	WHITE
PWR2 V+	•—————•	GREEN

CON 1 OPEN
 PIN ASSIGNMENTS

**The color is based on the optional power cable of Lantech.*

- Make sure the direction of connector is correct before you connect it.

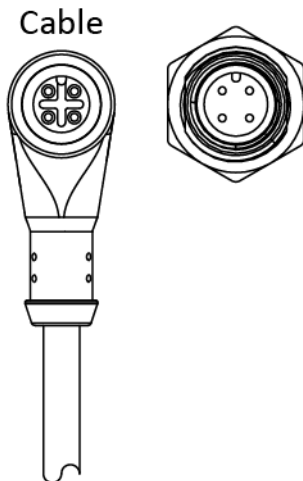

- Plug power connector and screw in clockwise direction to fix it.

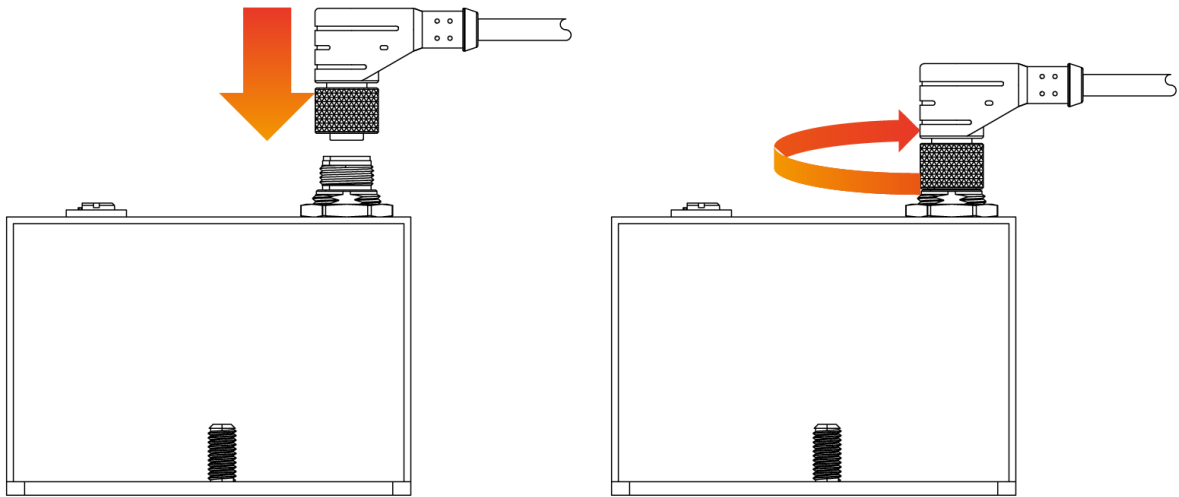

M12 4 PIN A-code to MCP connector



Case 1: Non-IGN model

PIN	Signal
1	V+, PWR2
2	V+, PWR1
3	V-, PWR1
4	V-, PWR2

PIN	Signal
1	24V after Manual Switch
2	Ground
3	24V after Ignition Switch
4	Full power available
5	Reserved
6	24V after Main Switch

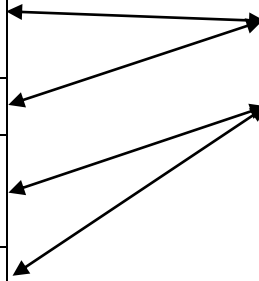

Case 2: IGN model, using the ignition function

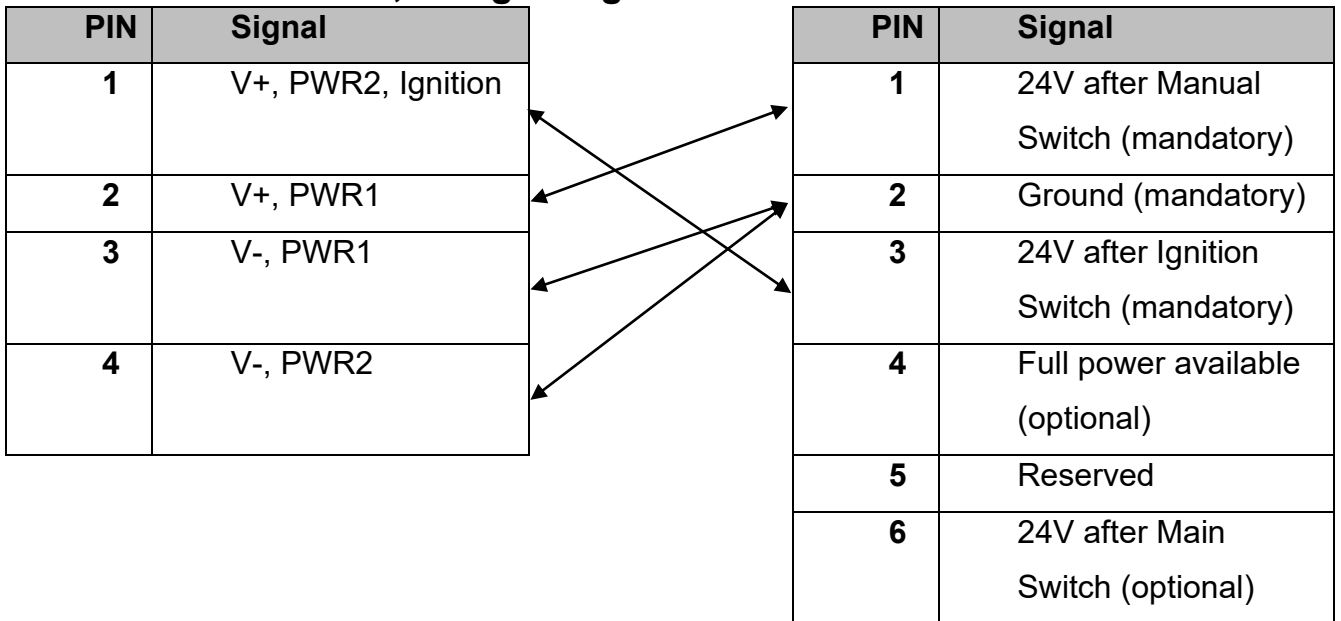

Case 3: IGN model, not using the ignition function

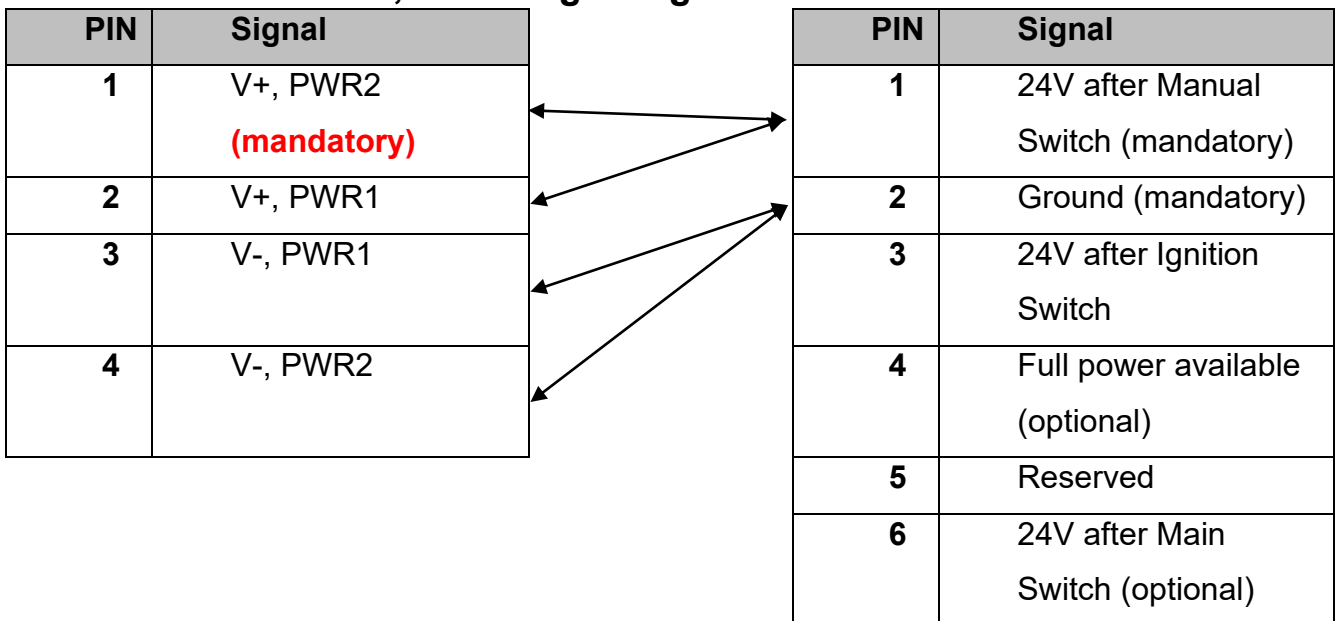

4.2 Ignition and PoE off timer

The switch supports a 10-minute PoE feeding OFF timer feature (customizable to other durations). The PoE feeding OFF timer only applies to the PoE functionality, while the switch system itself follows the ITxPT standard and remains active for 60 minutes. If an earlier system shutdown is required, please contact Lantech sales.

- Power supply interfaces shall be of MCP type, even in cases where the module makes use of PoE to ensure that the correct power control inputs are present (adapters on the module side are acceptable). MCP type connectors with 6 pins shall be used for power supply interfaces, such as TYCO reference: 1-965641-1 Blue Code A (vehicle side) or TYCO reference: 8-968970-1 Blue Code A (module side):



■ Ignition

When the vehicle has been stalled by the driver, some equipment in the car may still need to run for a while. With Lantech ignition switch, even if the engine of the vehicle has been turned off by driver, the switch can still offer power to the equipment via PoE connection from the battery.

3.2 10/100TX interface M12 connector

- Pin assignment of the 10/100Tx port

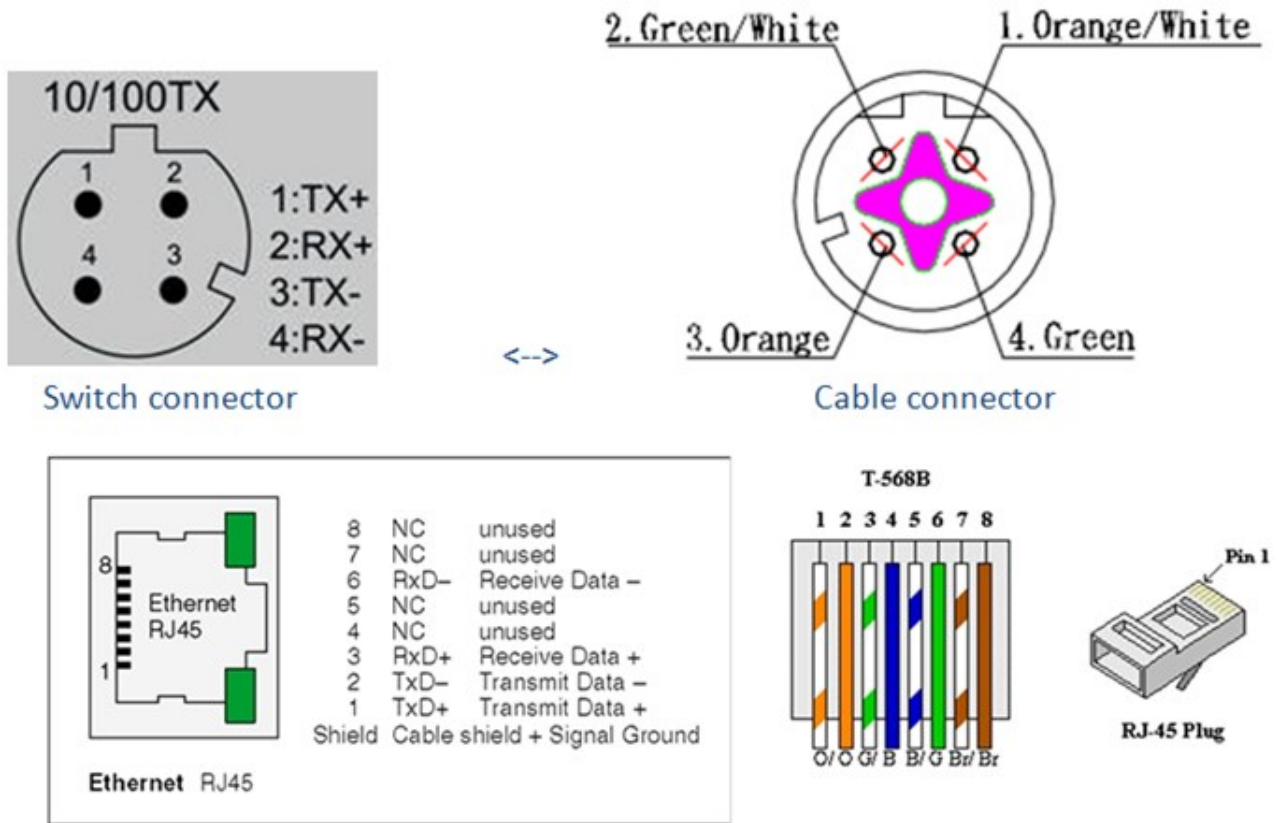

- Make sure the direction of connector is correct before you connect it.

Cable



- Plug the 10/100Tx connector and screw in clockwise direction to fix it.

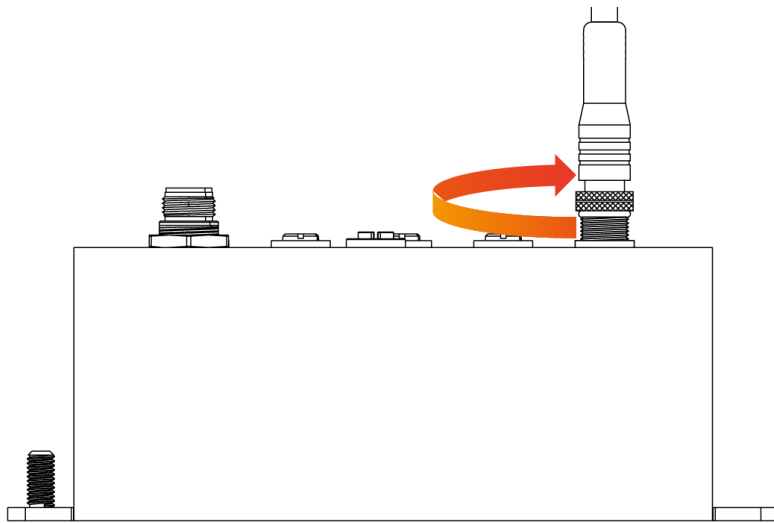
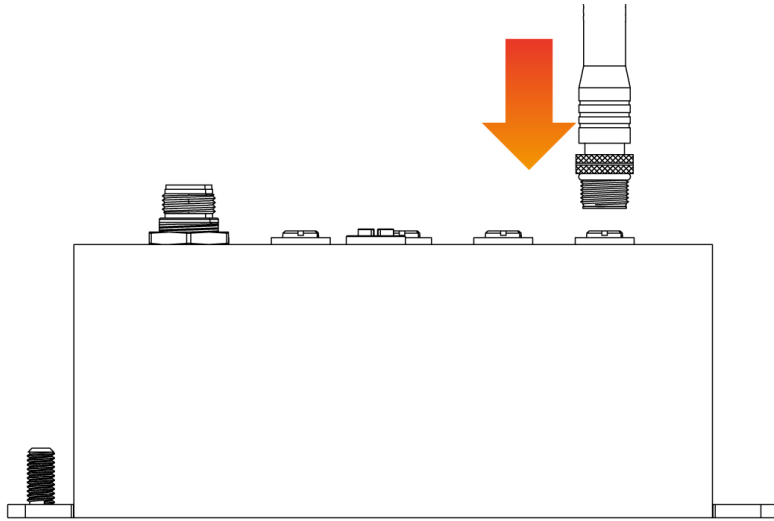

3.3 10/100/1000T interface M12 connector

- Pin assignment of the 10/100/1000T port

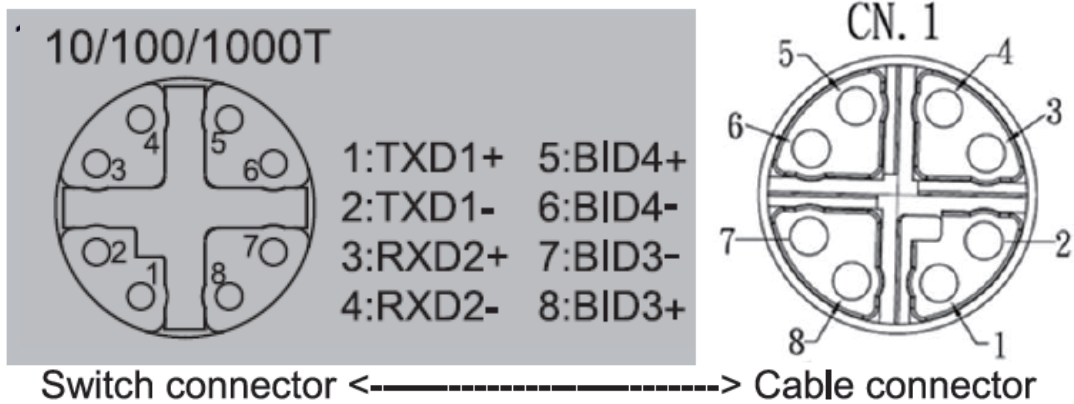

Shell	Gnd	Shell	
1	Orange/ White	1	TWIST
2	Orange	2	
3	Green/ White	3	TWIST
4	Green	6	
5	Brown/ White	7	TWIST
6	Brown	8	
7	Blue/ White	5	TWIST
8	Blue	4	
CN. 1	Wire Color	CN. 2	
	PIN	OUT	

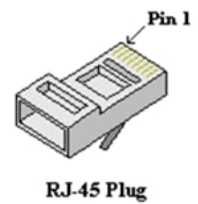
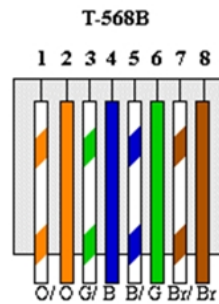

- Make sure the direction of connector is correct before you connect it.

Cable



- Plug the connector and screw in clockwise direction to fix it.

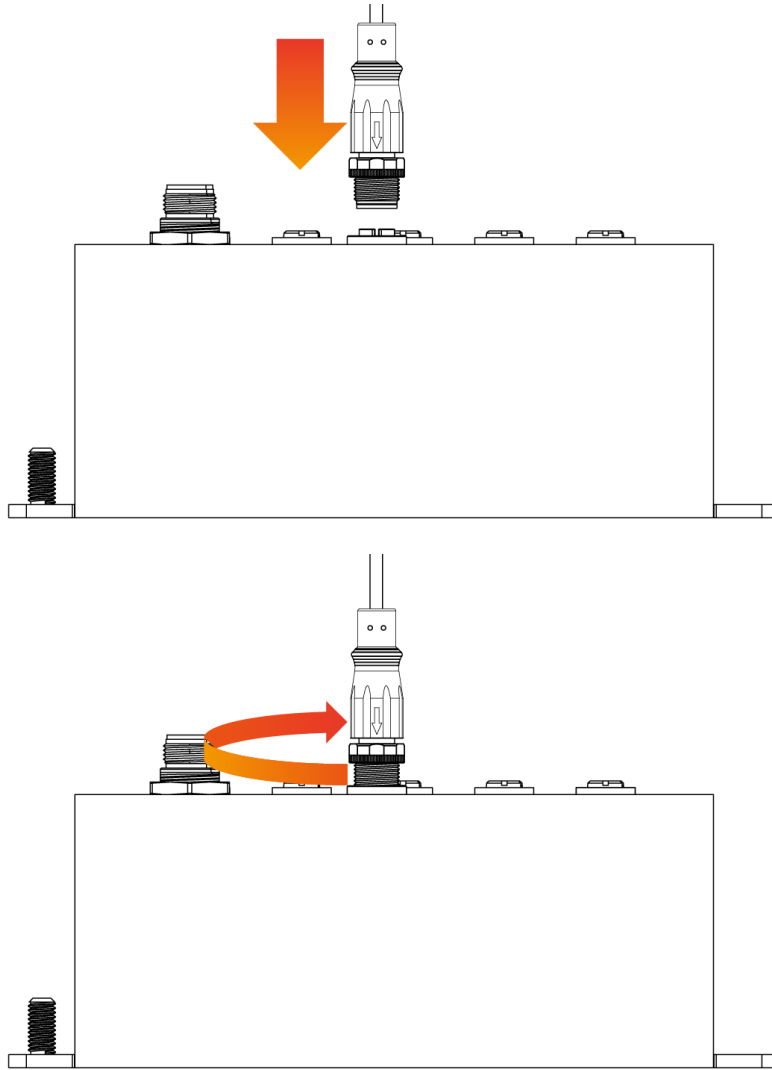

3.4 Ground interface M6 connector

Ground

The chassis is grounded via a separate grounding nut (M6).

Use toothed locking washers for a good electrical connection.

*** Note: The torque should not exceed 14 kilogram-force centimeters (kgf·cm), which is approximately 1.4 newton-meters (N·m). Applying torque beyond this limit may cause damage to the grounding components.**



Ground screw of the switch

Note:

- The protection class IP44 is only achieved when bolted together.
- The other components attaching to the system have to meet with the IP44 protection class in order to reach the whole system IP44 protection.
- Empty ports must be sealed with the protective caps supplied.

=====Notice=====

For web-based management, please refer to our “Software Management Manual”.
Please [contact us](#) for more information.