

Lantech

IPES/IES-0008B Series

8 10/100TX (w/8 PoE at/af) Industrial Un-Managed Switch

User Manual



Sep 2021

Recommendation for Shielded network cables

STP cables have additional shielding material that is used to reduce external interference. The shield also reduces the emission at any point in the path of the cable. Our recommendation is to deploy an STP network cable in demanding electrical environments. Examples of demanding indoor environments are where the network cable is located in parallel with electrical mains supply cables or where large inductive loads such as motors or contactors are in close vicinity to the camera or its cable. It is also mandatory to use an STP cable where the power device (like IP camera) is used outdoors or where the network cable is routed outdoors.

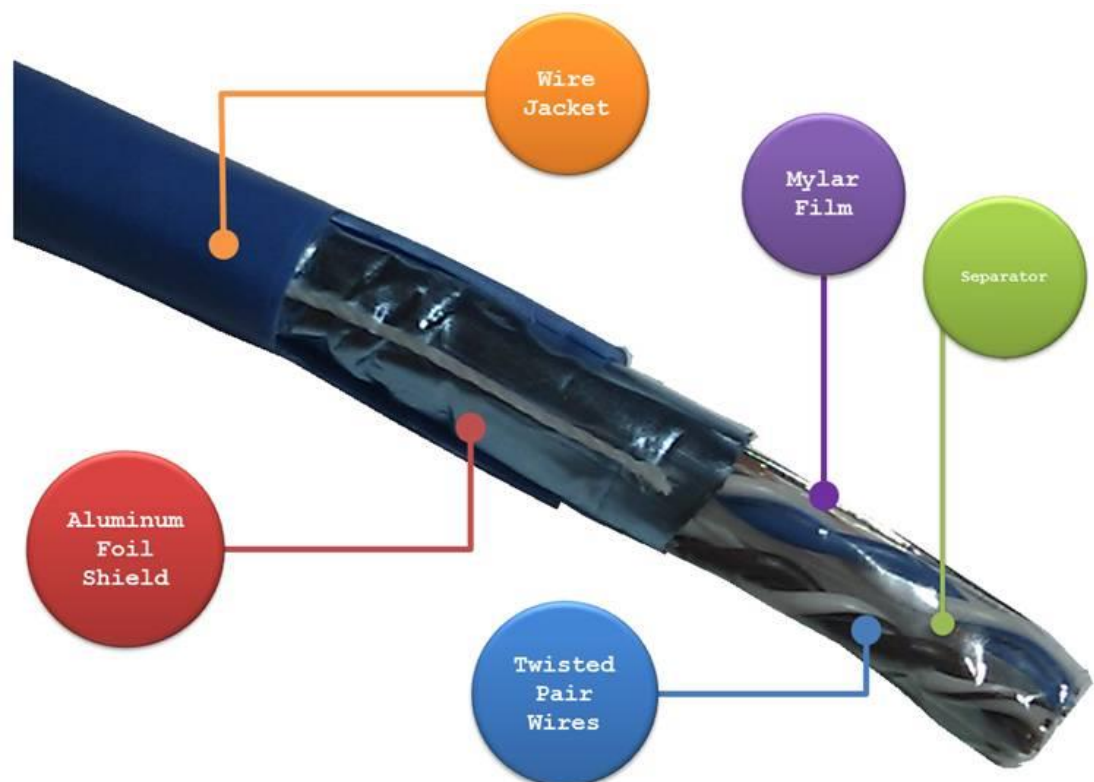

Important Notice

Lantech Communications Global, Inc. reserves the right to modify the equipment, its specification or this manual without prior notice, in the interest of improving performance, reliability, or servicing. At the time of publication all data is correct for the operation of the equipment at the voltage and/or temperature referred to. Performance *data* indicates typical values related to the particular product.

No part of this documentation or information supplied may be divulged to any third party without the express written consent of Lantech Communications Global Inc. Products offered may contain software which is proprietary to Lantech Communications Global Inc. The offer or supply of these products and services does not include or infer any transfer of ownership.

Interference Issues

This Equipment has been tested and found to comply with the limits for a Class A digital device, pursuant to Part 15 of the FCC rules. These limits are designed to provide reasonable protection against harmful interference in a commercial or industrial installation. This equipment generates, uses, and can radiate radio frequency energy. It may cause harmful interference to radio communications if the equipment is not installed and used in accordance with the instructions.

FCC Warning

This Equipment has been tested and found to comply with the limits for a Class-A digital device, pursuant to Part 15 of the FCC rules. These limits are designed to provide reasonable protection against harmful interference in a residential installation. This equipment generates, uses, and can radiate radio frequency energy. It may cause harmful interference to radio communications if the equipment is not installed and used in accordance with the instructions. However, there is no guarantee that interference will not occur in a particular installation. If this equipment does cause harmful interference to radio or television reception, which can be determined by turning the equipment off and on, the user is encouraged to try to correct the interference by one or more of the following measures:

- Reorient or relocate the receiving antenna.
- Increase the separation between the equipment and receiver.
- Connect the equipment into an outlet on a circuit different from that to which the receiver is connected.
- Consult the dealer or an experienced radio/TV technician for help.

CE Mark Warning

This is a Class-A product. In a domestic environment this product may cause radio interference in which case the user may be required to take adequate measures.

Content

Chapter 1 Introduction.....	5
Model Lists.....	5
Chapter 2 Hardware Description	5
2.1 Physical Dimension.....	5
2.2 Package Content:.....	7
2.3 IP Protection.....	8
2.4 LED Indicators.....	11
Chapter 3 Hardware Installation	12

Chapter 1 Introduction

Lantech IPES/IES-0008B Series are 8 10/100 Base-TX with M12-connector unmanaged industrial switches for IP41/IP54 rated protection, which meet the high reliability requirements demanded by industrial rolling stock applications.

Model Lists

Model name	10/100TX ports	PoE ports	Power input
IPES-0008B-41/54-12V	8	8	Dual 9~56VDC
IPES-0008B-41/54-12V (5A)	8	8	Dual 9~36VDC
IPES-0008B-41/54-72V	8	8	Dual 50.4~90VDC
IES-0008B-41/54-12V	8	NA	Dual 9.5~60VDC
IES-0008B-41/54-72V	8	NA	Dual 50.4~90VDC

For latest product specifications, please refer to [Lantech official site](#).

Chapter 2 Hardware Description

In this paragraph, it will describe the Industrial switch's hardware spec, port, cabling information, and wiring installation.

2.1 Physical Dimension

Aluminum case. IP-41,

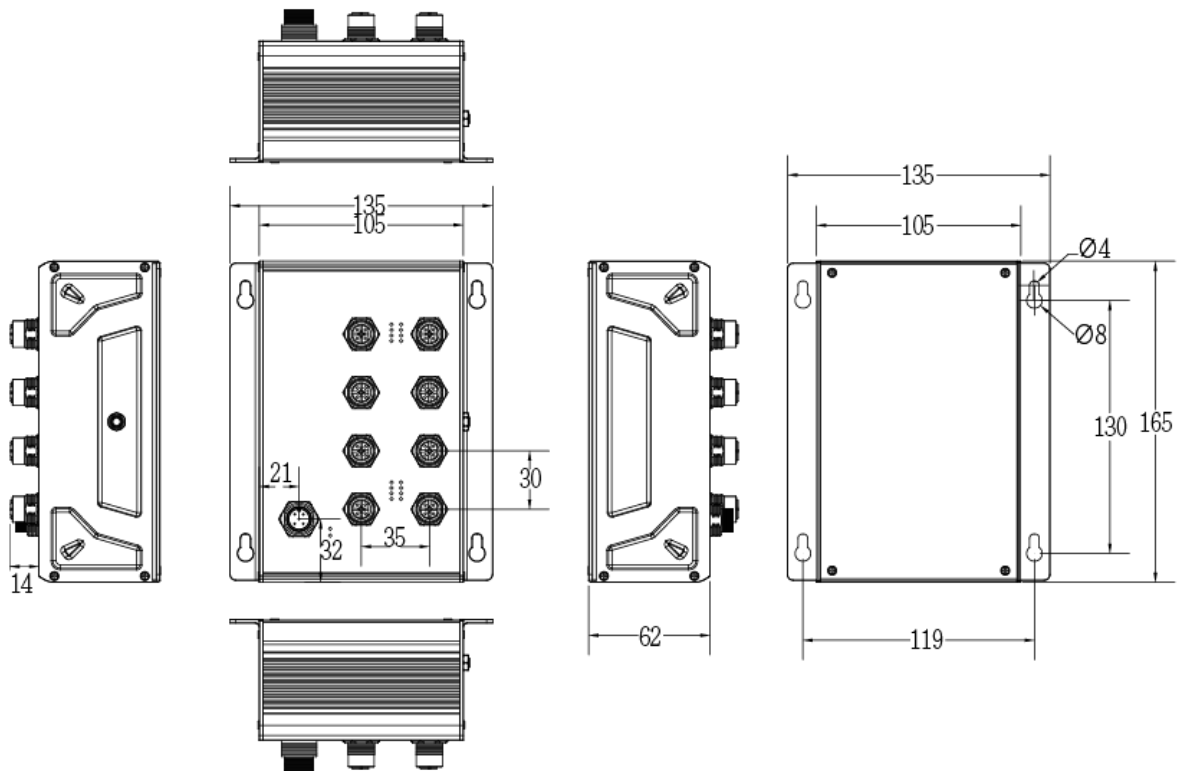

Aluminum case. IP-54,

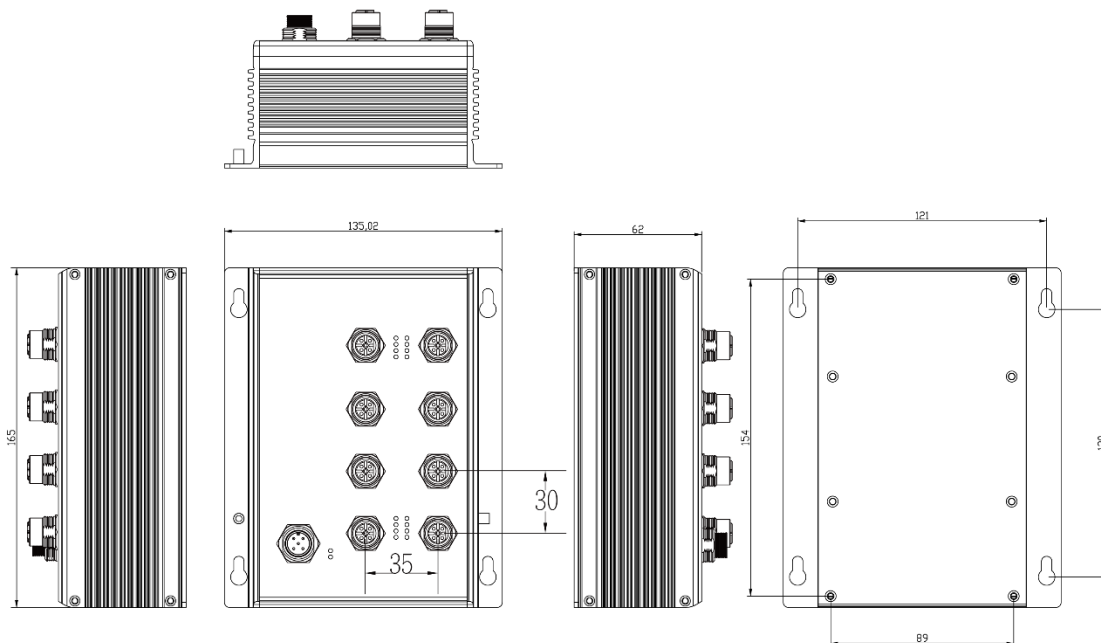

2.2 Package Content:



Manual CD*



Product

*By request

2.3 IP Protection

The **IP Code, Ingress Protection Rating**, sometimes also interpreted as **International Protection Rating**, classifies and rates the degree of protection provided against the intrusion (including body parts such as hands and fingers), dust, accidental contact, and water in *mechanical casings* and with electrical enclosures. It is published by the International Electrotechnical Commission (IEC)

Solid particle protection

The first digit indicates the level of protection that the enclosure provides against access to hazardous parts (e.g., electrical conductors, moving parts) and the ingress of solid foreign objects.

Level	Object size protected against	Effective against
0	—	No protection against contact and ingress of objects
1	>50 mm	Any large surface of the body, such as the back of a hand, but no protection against deliberate contact with a body part
2	>12.5 mm	Fingers or similar objects
3	>2.5 mm	Tools, thick wires, etc.
4	>1 mm	Most wires, screws, etc.
5	Dust protected	Ingress of dust is not entirely prevented, but it must not enter in sufficient quantity to interfere with the satisfactory operation of the equipment; complete protection against contact
6	Dust tight	No ingress of dust; complete protection against contact

Liquid ingress protection

The second digit indicates the level of protection that the enclosure provides against harmful ingress of water.

Level	Protected against	Testing for	Details
0	Not protected	—	—
1	Dripping water	Dripping water (vertically falling drops) shall have no harmful effect.	Test duration: 10 minutes Water equivalent to 1 mm rainfall per minute
2	Dripping water when tilted up to 15°	Vertically dripping water shall have no harmful effect when the enclosure is tilted at an angle up to 15° from its normal position.	Test duration: 10 minutes Water equivalent to 3 mm rainfall per minute
3	Spraying water	Water falling as a spray at any angle up to 60° from the vertical shall have no harmful effect.	Test duration: 5 minutes Water volume: 0.7 litres per minute Pressure: 80–100 kPa
4	Splashing of water	Water splashing against the enclosure from any direction shall have no harmful effect.	Test duration: 5 minutes Water volume: 10 litres per minute Pressure: 80–100 kPa
5	Water jets	Water projected by a nozzle (6.3 mm) against enclosure from any direction shall have no harmful effects.	Test duration: at least 15 minutes Water volume: 12.5 litres per minute Pressure: 30 kPa at distance of 3 m

6	Powerful water jets	Water projected in powerful jets (12.5 mm nozzle) against the enclosure from any direction shall have no harmful effects.	Test duration: at least 3 minutes Water volume: 100 litres per minute Pressure: 100 kPa at distance of 3 m
7	Immersion up to 1 m	Ingress of water in harmful quantity shall not be possible when the enclosure is immersed in water under defined conditions of pressure and time (up to 1 m of submersion).	Test duration: 30 minutes Immersion at depth of at least 1 m measured at bottom of device, and at least 15 cm measured at top of device
8	Immersion beyond 1 m	The equipment is suitable for continuous immersion in water under conditions which shall be specified by the manufacturer. Normally, this will mean that the equipment is hermetically sealed. However, with certain types of equipment, it can mean that water can enter but only in such a manner that it produces no harmful effects.	Test duration: continuous immersion in water Depth specified by manufacturer
9	Powerful high temperature water jets	Protected against close-range high pressure, high temperature spray downs.	—

2.4 LED Indicators

The diagnostic LEDs that provide real-time information of system and optional status are located on the front panel of the industrial switch. The following table provides the description of the LED status and their meanings for the switch.

LED	Color	Status	Meaning
PWR1	Green	On	Power 1 is active
		Off	Power 1 is inactive
PWR2	Green	On	Power 2 is active
		Off	Power 2 is inactive
P1 ~ P8	Link/Ack	On	A network device is detected.
		Blinking	The port is transmitting or receiving packets from the TX device.
		Off	No device attached
	PoE(1~8)(IPES)	On	The port is operating in PoE mode.(IPES)
		Off	The port is not operating in PoE mode.(IPES)

Chapter 3 Hardware Installation

3.1 Hardware installation

For PoE models: If this switch needs to uplink with another switch via a PoE copper port, please make sure the uplink port on the other unit is a none-PoE interface. You may also contact our sales team to confirm if the switch supports power isolation.

It is recommended when installing an Ethernet switch without PoE isolation, and you intend to use this function then a DC-DC galvanic isolated converter should be used in between the train power supply and the switch.

3.1.1 Unpack switch and check the accessory with packing content list

3.1.2 Mount the switch on desired position. For the best ventilation, it is suggested to mount the switch on metallic surface.

3.1.3 Connect the M12 connector of power input. The power supply for IPES-0008B series is connected via a 5-pole M12 female connector while IES-0008B is with a 5-pole M12 female connector as well.

■ Voltage of Power Input & PoE budget

Model name	Power input	PoE budget
IPES-0008B-41/54-12V	Dual 9~56VDC	60W for 12V input (80W at dual input) 120W for 24V/36V input 80W for 72V Input (54V input is recommended for PTZ or heater applications)
IPES-0008B-41/54-12V (5A)	Dual 9~36VDC	
IPES-0008B-41/54-72V	Dual 50.4~90VDC	
IES-0008B-41/54-12V	Dual 9.5~60VDC	NA
IES-0008B-41/54-72V	Dual 50.4~90VDC	NA

Please make sure that the external power supply unit you use to provide the PoE voltage meet the following criteria:

- The power consumption can satisfy the total power request from all PD devices required.

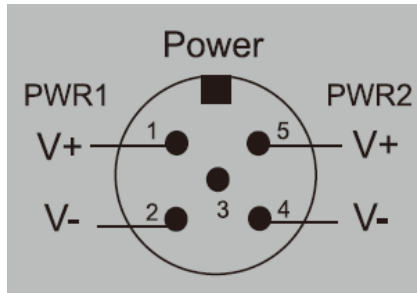

Pin assignment of Power input (Shipping before Q1 2018)

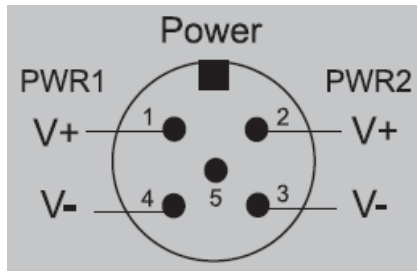

Pin assignment of Power input (Shipping after Jan 2018)

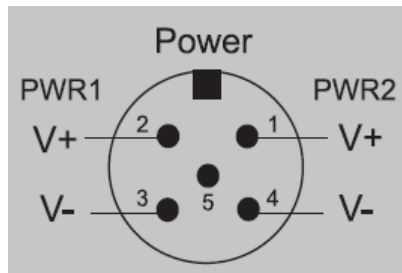

Pin assignment of Power input (Shipping after May 2018)

■ Redundant Power Input

The power input can be supported redundantly. The supply voltage is electrically isolated from the housing.

3.1.4 Fitting the device, grounding

Install the system in a dry and clean area to protect the switch to get exposed with dirt.

Plug the connector to the power supply plug then turn on the power supply.

■ **Ground**

The chassis is grounded via a separate ground nut (M3).

Use toothed locking washers for a good electrical connection.

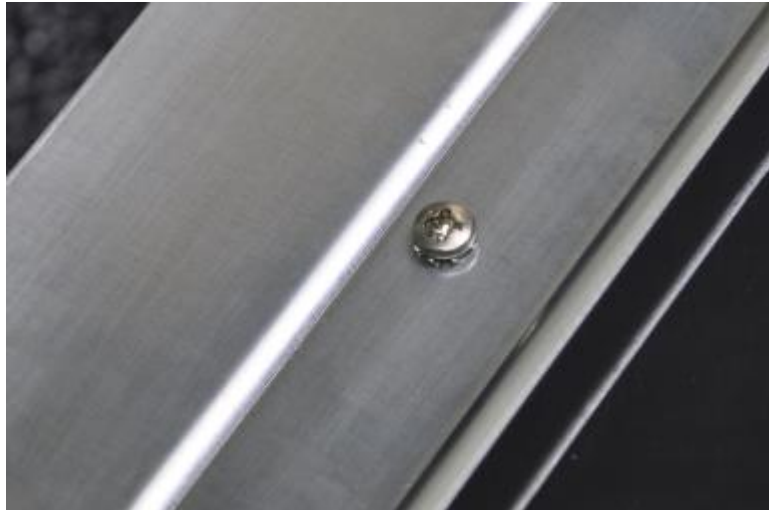

Ground screw of I(P)ES-0008B switch

3.1.5 Connect the M12 connector with RJ-45 data cable, ports are not used shall be capped that comes with the package to insulate the surrounding.

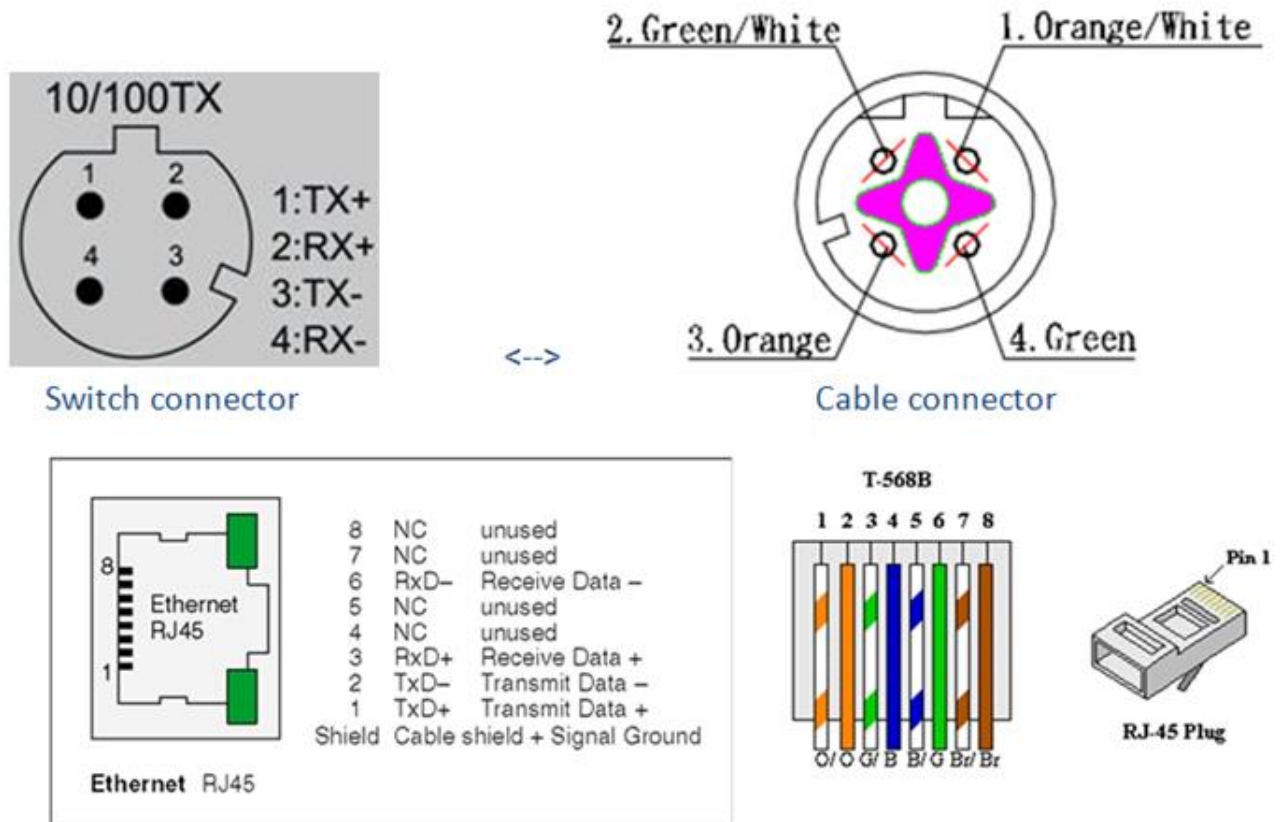

Pin assignment of M12 10/100Tx network connector

3.1.6 Check the status of LED, make sure the switch was in working status.

Note:

- The protection class IP41/54 is only achieved when bolted together.
- The other components attaching to the system have to meet with the IP41/54 protection class in order to reach the whole system IP41/54 protection.
- Empty ports must be sealed with the protective caps supplied.