

Lantech

IPES-0204DFT-4

4 10/100TX PoE at/af + 1 10/100/1000T + 1 Dual Speed SFP Industrial Unmanaged Switch

IPES-0104GT-4

4 10/100TX PoE at/af + 1 10/100/1000T Industrial Unmanaged Switch

IES-0204DFT

4 10/100TX + 1 10/100/1000T + 1 Dual Speed SFP Industrial Unmanaged Switch

User Manual



V1.05
Oct. 2023

Recommendation for Shielded network cables

STP cables have additional shielding material that is used to reduce external interference. The shield also reduces the emission at any point in the path of the cable. Our recommendation is to deploy an STP network cable in demanding electrical environments. Examples of demanding indoor environments are where the network cable is located in parallel with electrical mains supply cables or where large inductive loads such as motors or contactors are in close vicinity to the camera or its cable. It is also mandatory to use an STP cable where the power device (like IP camera) is used outdoors or where the network cable is routed outdoors.

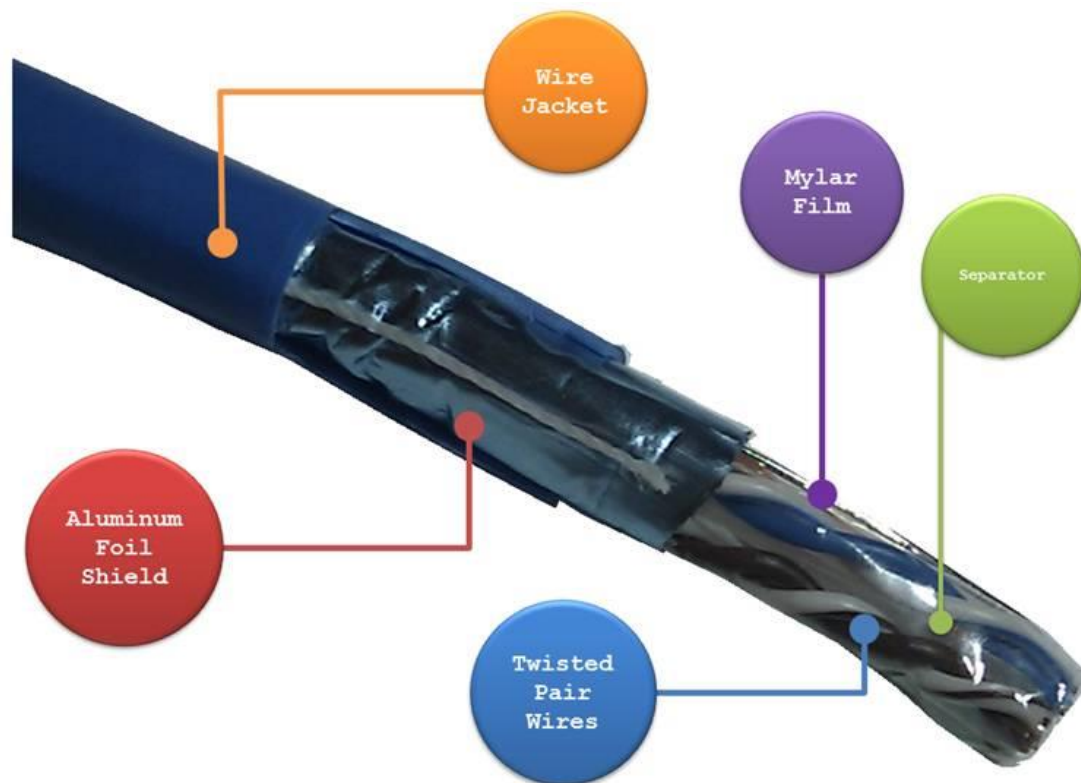

Content

Overview	1
Introduction	1
Features / Model List.....	2
Packing List.....	3
Safety Precaution.....	3
Hardware Description.....	4
Dimensions	5
Wiring the Power Inputs	8
Wiring the Fault Alarm Contact	9
LED Indicators.....	10
Dip Switch (IES-0204DFT / IPES-0204DFT-4)	11
RJ-45 Pin Assignments.....	12
Cabling	14
Mounting Installation	18
DIN-Rail Mounting.....	18
Wall-Mount Plate Mounting (Optional)	20
Hardware Installation	21

Installation Steps	22
Troubleshooting	23

Important Notice

Lantech Communications Global, Inc. reserves the right to modify the equipment, its specification or this manual without prior notice, in the interest of improving performance, reliability, or servicing. At the time of publication all data is correct for the operation of the equipment at the voltage and/or temperature referred to. Performance data indicates typical values related to the particular product.

No part of this documentation or information supplied may be divulged to any third party without the express written consent of Lantech Communications Global Inc. Products offered may contain software which is proprietary to Lantech Communications Global Inc. The offer or supply of these products and services does not include or infer any transfer of ownership.

Interference Issues

This Equipment has been tested and found to comply with the limits for a Class A digital device, pursuant to Part 15 of the FCC rules. These limits are designed to provide reasonable protection against harmful interference in a commercial or industrial installation. This equipment generates, uses, and can radiate radio frequency energy. It may cause harmful interference to radio communications if the equipment is not installed and used in accordance with the instructions.

FCC Warning

This Equipment has been tested and found to comply with the limits for a Class-A digital device, pursuant to Part 15 of the FCC rules. These limits are designed to provide reasonable protection against harmful interference in a residential installation. This equipment generates, uses, and can radiate radio frequency energy. It may cause harmful interference to radio communications if the equipment is not installed and used in accordance with the instructions. However, there is no guarantee that interference will not occur in a particular installation. If this equipment does cause harmful interference to radio or television reception, which can be determined by turning the equipment off and on, the user is encouraged to try to correct the interference by one or more of the following measures:

- Reorient or relocate the receiving antenna.
- Increase the separation between the equipment and receiver.
- Connect the equipment into an outlet on a circuit different from that to which the receiver is connected.
- Consult the dealer or an experienced radio/TV technician for help.

CE Mark Warning

This is a Class-A product. In a domestic environment this product may cause radio interference in which case the user may be required to take adequate measures.

Overview

Introduction

The unmanaged industrial switch is a cost-effective solution and meets the high reliability requirements demanded by industrial applications.

High-Speed Transmissions

The Industrial switch includes a switch controller that can automatically sense transmission speeds (10/100/1000 Mbps). The RJ-45 interface can also be auto-detected, so MDI or MDI-X is automatically selected and a crossover cable is not required. All Ethernet ports have memory buffers that support the store-and-forward mechanism. This assures that data is properly transmitted.

Dual Power Inputs

To reduce the risk of power failure, the Industrial switch provides dual power inputs. When power failure occurs, the device will automatically switch to the secondary power input.

Flexible Mounting

The industrial switch is extremely compact and can be mounted on a DIN-rail or a panel, so it is suitable for any space-constrained environment.

Wide Operating Temperature

The operating temperature of the Industrial switch is in the range between -20 ~ 60°C or -40 ~ 75°C. With such a wide range, you can use the Industrial switch in some of the harshest industrial environments that exist.

Easy Troubleshooting

LED indicators make troubleshooting quick and easy. Each RJ45 port has 2 LED indicators that display the link status, transmission speed and collision status. Also other LED indicators help you diagnose the system immediately.

Features / Model List

- Store-and-Forward switching architecture
- 8K MAC address table
- Supports full/half duplex flow control
- IEEE 802.3at/af PoE+ standard (PoE models)
- Supports MDI/MDI-X auto-crossover
- Relay contact to connect with alarm system
- Provides flexible mounting: DIN-rail, Panel Mounting*

Model Name	10/100TX	10/100/1000T	100/1000M SFP	Power Supply	Operating Temperature
IPES-0104GT-4-48V	4 (PoE)	1	0	45~57VDC	-20 ~ 60°C
IPES-0104GT-4-48V-E	4 (PoE)	1	0	45~57VDC	-40 ~ 75°C
IPES-0104GT-4-12V	4 (PoE)	1	0	9.5~57VDC	-20 ~ 60°C
IPES-0104GT-4-12V-E	4 (PoE)	1	0	9.5~57VDC	-40 ~ 75°C
IPES-0204DFT-4-48V	4 (PoE)	1	1	45~57VDC	-40 ~ 75°C
IPES-0204DFT-4-12V	4 (PoE)	1	1	9.5~57VDC	-40 ~ 75°C
IES-0204DFT	4	1	1	9.5~60VDC	-40 ~ 75°C

*Optional

Packing List

- 1 x Industrial Ethernet Switch (w/ terminal block and DIN-Rail kit)
- Caps for RJ45-port and SFP-port

Safety Precaution

Attention If DC voltage is supplied by an external circuit, please use a protection device on the power supply input.

Hardware Description

In this paragraph, we will introduce the Industrial switch's dimensions, port, cabling information, and wiring installation.

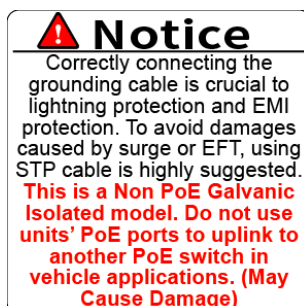

For POE models: Do not use units' POE ports to uplink to another POE switch in vehicle applications. (May Cause Damage) Lantech strongly advise the installation of a Galvanic isolated DC/DC converter between the power supply and the Ethernet switch on all Non-Isolated models. Please contact the sales team for advice on which models support isolated power design.

For PoE 48V models, the output voltage of power supply must exceed 48VDC for 802.3af and 53VDC for 802.3at operation.

Dimensions

IPES-0204DFT-4-48V:

35 x 152 x 105 mm (W x H x D)

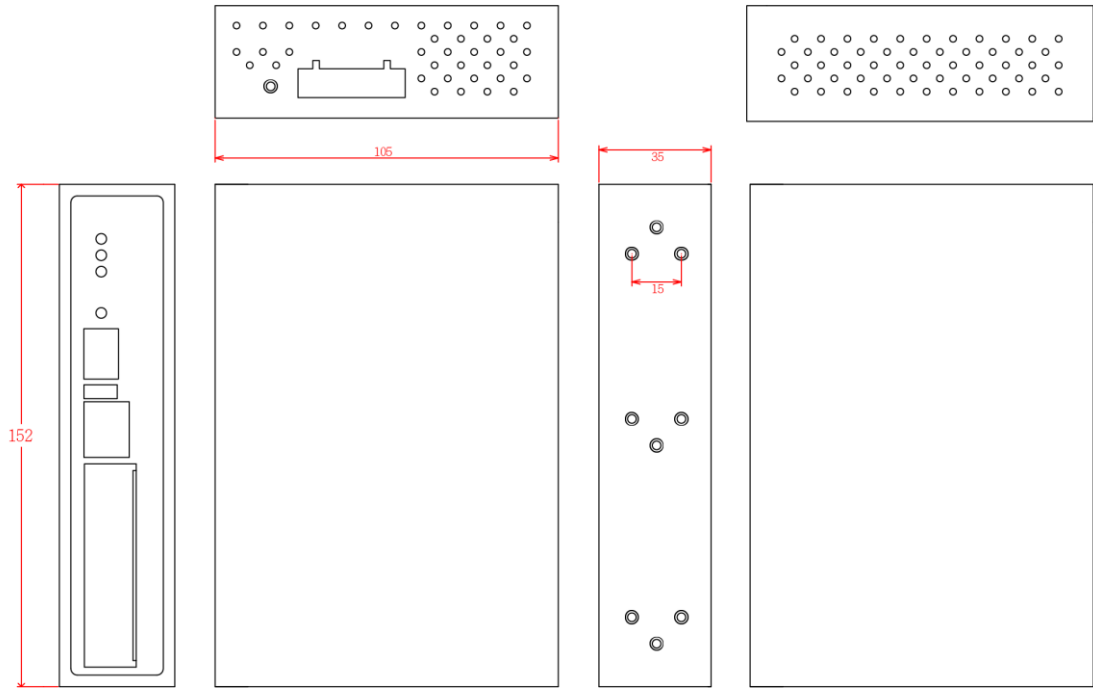

IPES-0204DFT-4-12V:

43 x 152 x 105 mm (W x H x D)

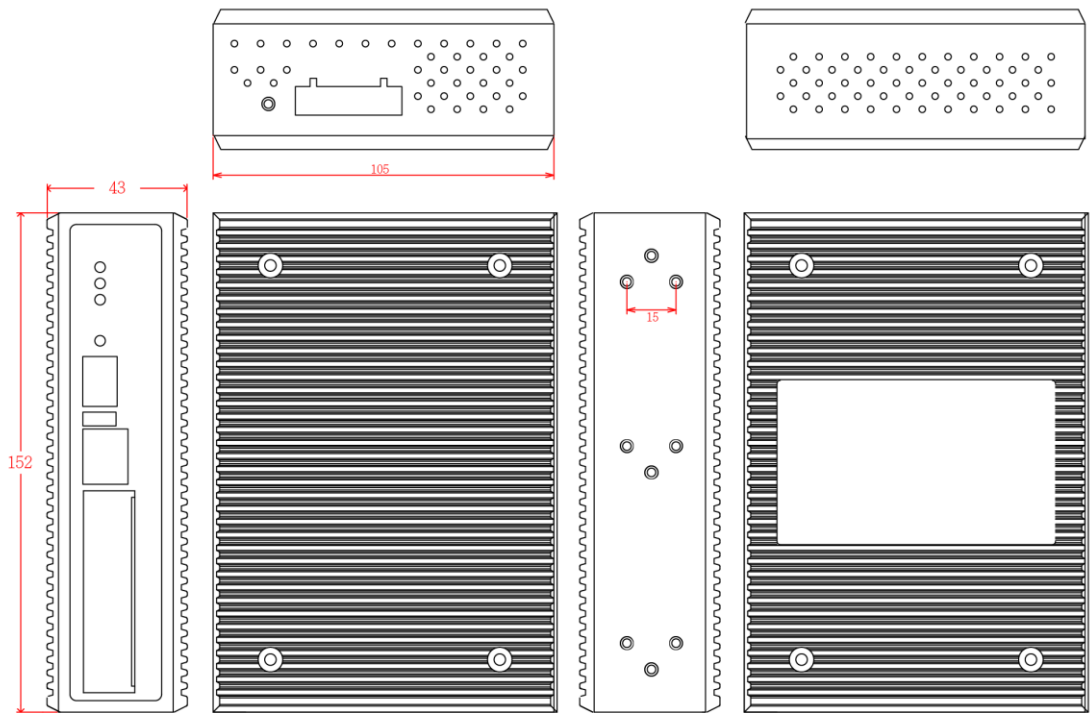

IPES-0104GT-4-48V / IPES-0104GT-4-48V-E:

35 x 152 x 105 mm (W x H x D)

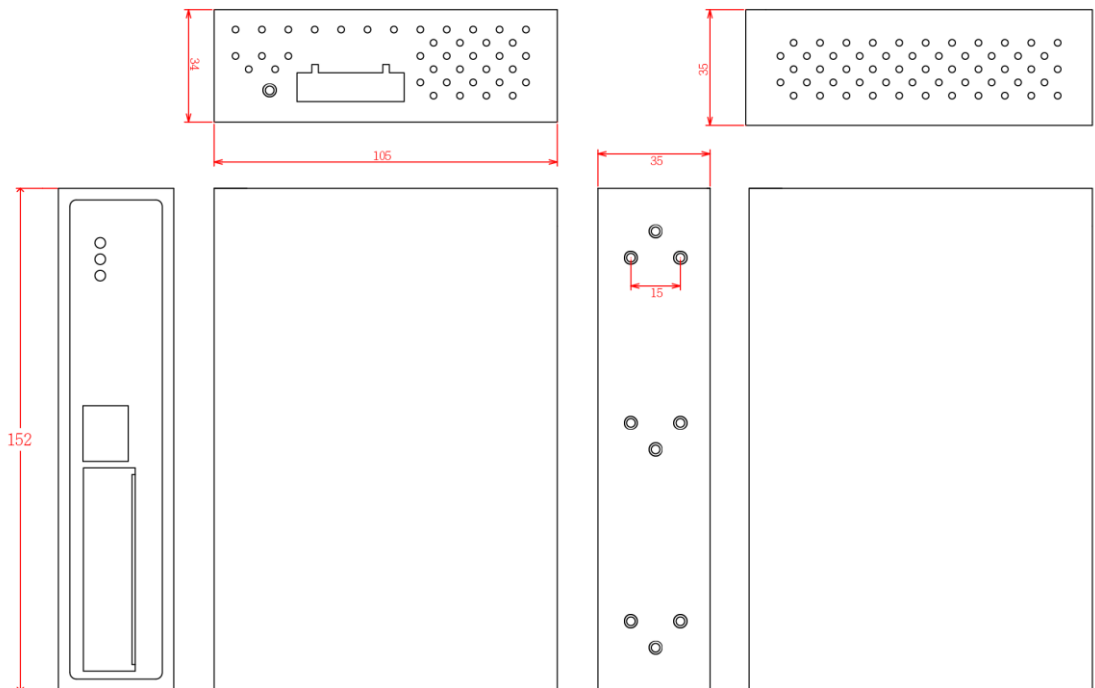

IPES-0104GT-4-12V / IPES-0104GT-4-12V-E:

43 x 152 x 105 mm (W x H x D)

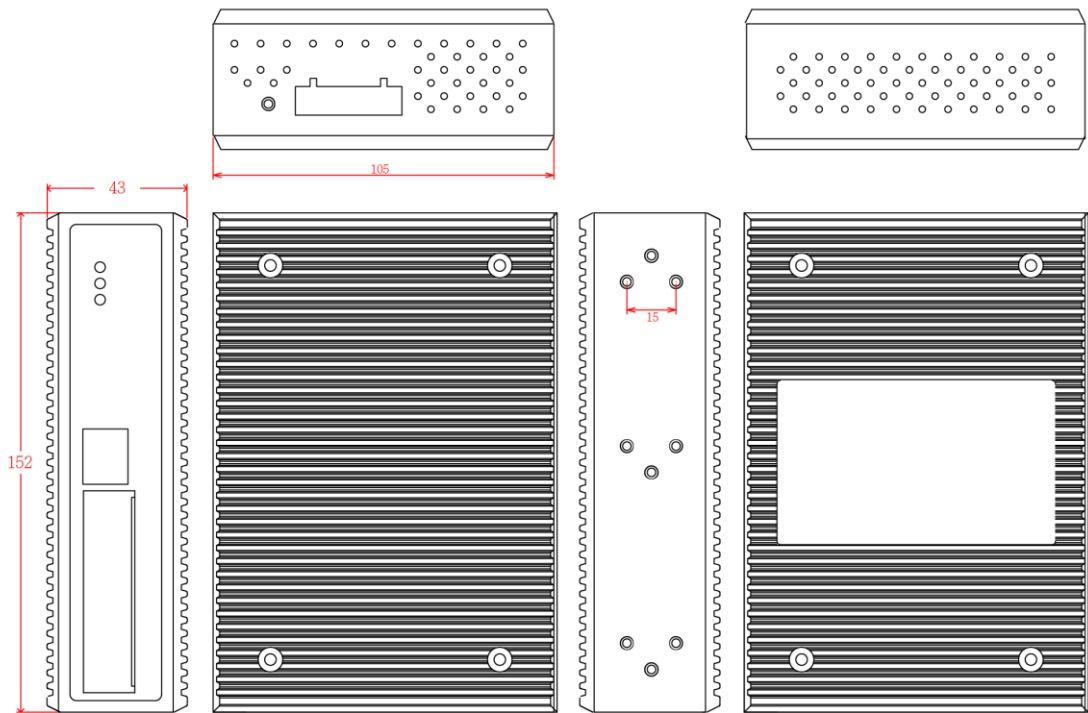

IES-0204DFT:

35 x 152 x 105 mm (W x H x D)

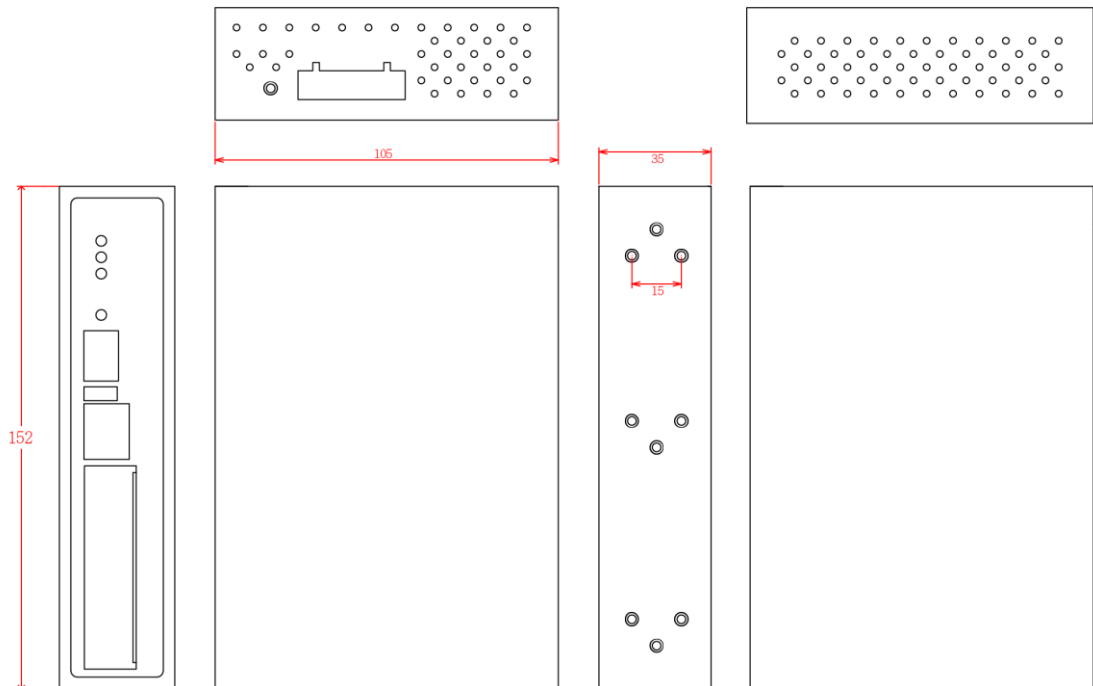

Wiring the Power Inputs

Please follow the steps below to insert the power wires.

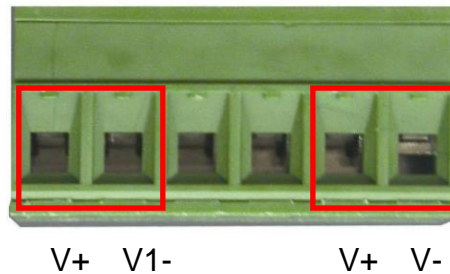

1. Insert the positive and negative wires into the V+ and V- contacts on the terminal block connector.

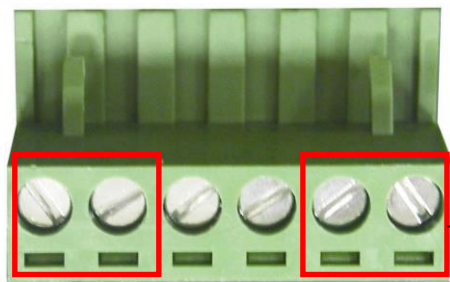

2. Tighten the wire-clamp screws to prevent the DC wires from loosening.

Note *The wire gauge for the terminal block should be in the range between 12~ 24 AWG.
50-57VDC input is recommended for 802.3at 30W applications.*

Wiring the Fault Alarm Contact

The fault alarm contacts are in the middle of the terminal block connector as the picture shows below. Inserting the wires, the switch will detect the fault status of the power failure, or port link failure (available for managed model) and then forms an open circuit. The following illustration shows an application example for wiring the fault alarm contacts.

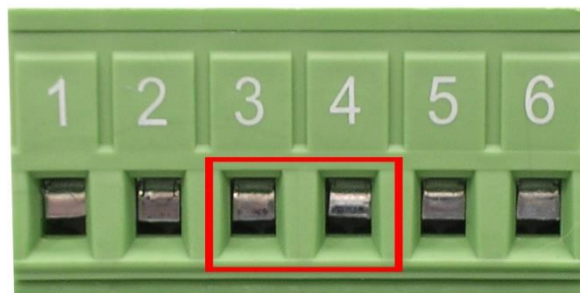

Insert the wires into the fault alarm contacts

[NOTE] The wire gauge for the terminal block should be in the range between 12 ~ 24 AWG.

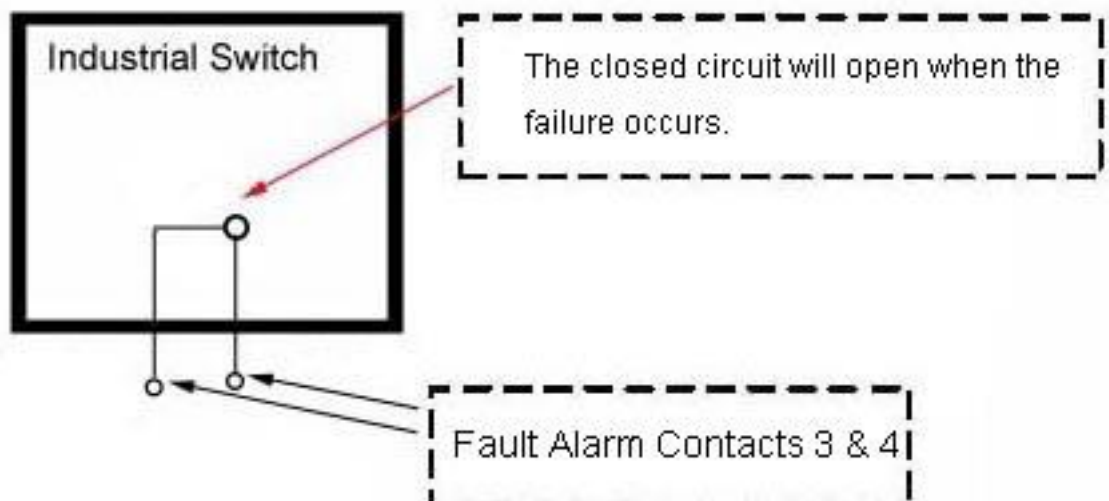

LED Indicators

IES-0204DFT	IPES-0104GT-4-48V IPES-0104GT-4-48V-E IPES-0104GT-4-12V IPES-0104GT-4-12V-E	IPES-0204DFT-4-48V IPES-0204DFT-4-12V
<p>Lantech IES-0204DFT 4 10/100TX + 1 10/100/1000T + 1 Dual Speed SFP Industrial Switch</p> <p>PWR1 PWR2 FAULT</p> <p>100/1000M 1000M</p> <p>10/100/1000T FDX/COL LNK/ACT</p> <p>4 PoE 3 PoE 2 PoE 1 PoE</p> <p>LNK/ACT</p> <p>10/100TX</p>	<p>Lantech IPES-0104GT-4 4 10/100TX PoE aStar + 1 10/100/1000T Industrial Switch</p> <p>PWR1 PWR2 FAULT</p> <p>10/100/1000T FDX/COL LNK/ACT</p> <p>4 PoE 3 PoE 2 PoE 1 PoE</p> <p>LNK/ACT</p> <p>10/100TX</p>	<p>Lantech IPES-0204DFT-4 4 10/100TX PoE aStar + 1 10/100/1000T + 1 Dual Speed SFP Industrial Switch</p> <p>PWR1 PWR2 FAULT</p> <p>100/1000M 1000M</p> <p>10/100/1000T FDX/COL LNK/ACT</p> <p>4 PoE 3 PoE 2 PoE 1 PoE</p> <p>LNK/ACT</p> <p>10/100TX</p>

The LED indicators located on the front panel display the power status and network status of the Industrial switch; each has their own specific meaning as the table shown below.

LED	Color	Description	
PWR1	Green	On	Power input 1 is active
		Off	Power input 1 is inactive
PWR2	Green	On	Power input 2 is active
		Off	Power input 2 is inactive
Fault	Red	On	Power input 1 or 2 is inactive
		Off	Power input 1 and 2 are both functional, or no power inputs
6	Green	On	A network device is detected.
		Blinking	The port is transmitting or receiving packets from the TX device.
LNK/ACT	Green	On	A network device is detected.
		Blinking	The port is transmitting or receiving packets from the TX device.
FDX/COL	Yellow	On	Full-duplex mode
		Blinking	Collision occurs
PoE	Yellow	On	The port is operating in PoE mode.
		Off	The port is not operating in PoE mode.

Dip Switch (IES-0204DFT / IPES-0204DFT-4)

The SFP speed can be selected by switching the DIP switch.

(The DIP switch will not work when switch is in power on status, please set the DIP then power on the switch.)



RJ-45 Pin Assignments

The UTP/STP ports will automatically sense for Fast Ethernet (10Base-T/100Base-TX) or Gigabit Ethernet (10Base-T/100Base-TX/1000Base-T) connection. Auto MDI/MDIX means that the switch can connect to another switch or workstation without changing straight through or crossover cabling. See the figures below for straight through and crossover cable schema.

■ 10/100Base-TX Pinouts

Pin Number	Assignment
1	Tx+
2	Tx-
3	Rx+
6	Rx-

Note “+” and “-” signs represent the polarity of the wires that make up each wire pair.

The table below shows the 10Base-T/100Base-TX MDI and MDI-X port pinouts.

Pin Number	MDI-X Signal Name	MDI Signal Name
1	Receive Data plus (RD+)	Transmit Data plus (TD+)
2	Receive Data minus (RD-)	Transmit Data minus (TD-)
3	Transmit Data plus (TD+)	Receive Data plus (RD+)
6	Transmit Data minus (TD-)	Receive Data minus (RD-)

■ **10/100Base-TX Cable Schema**

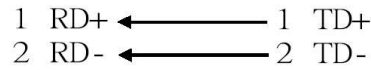
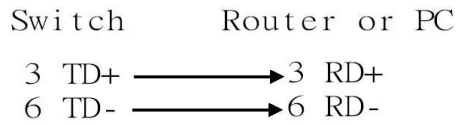

Straight Through Cable Schema

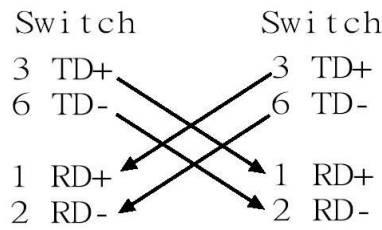

Crossover Cable Schema

■ **10/100/1000Base-T Pinouts**

The table below describes the gigabit Ethernet RJ-45 pinouts.

Pin	Signal name	Description
1	BI_DA+	Bi-directional pair A+
2	BI_DA-	Bi-directional pair A-
3	BI_DB+	Bi-directional pair B+
4	BI_DC+	Bi-directional pair C+
5	BI_DC-	Bi-directional pair C-
6	BI_DB-	Bi-directional pair B-
7	BI_DD+	Bi-directional pair D+
8	BI_DD-	Bi-directional pair D-

■ **10/100/1000Base-T Cable Schema**

The following two figures illustrate the 10/100/1000Base-T cable schema.

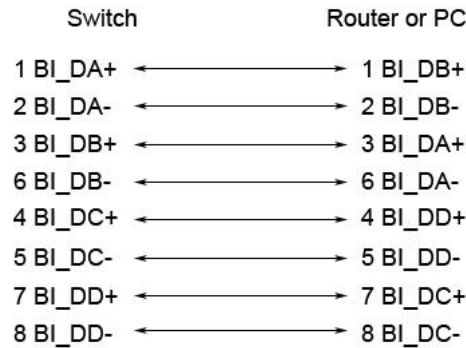

Straight Through Cable Schema

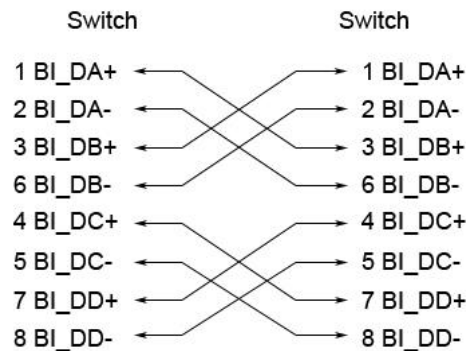

Crossover Cable Schema

Cabling

- Use unshielded twisted-pair (UTP) or shielded twisted-pair (STP) cable for RJ-45 connections: 100Ω Category 3, 4 or 5 cable for 10Mbps connections, 100Ω Category 5 cable for 100Mbps, or 100Ω Category 5e/above cable for 1000Mbps connections. The cable between the switch and the link partner (switch, hub, workstation, etc.) must be less than 100 meters (328 ft.) long.
- Fiber segment using **single-mode** connector type must use 9/125 μm single-mode fiber cable. User can connect two devices in the distance

up to **30km**.

- Fiber segment using **multi-mode** connector type must use 50 or 62.5/125 μm multi-mode fiber cable. User can connect two devices up to **2km** distances.

- **Gigabit / 100M SFP port:**

The small form-factor pluggable (SFP) is a compact optical transceiver used in optical communications for both telecommunication and data communications. The SFP slots supporting Gigabit speed up to 1000Mbps. –DSFP/-DFT models support dual speed 100M or 1000Mbps. They are used for connecting to the network segment with single or multi-mode fiber. You can choose the appropriate SFP transceiver to plug into the slots. Then use proper multi-mode or single-mode fiber according to the transceiver. With fiber optic, it transmits at speed up to 1000 Mbps or dual speed (-DSFP/-DFT models) and you can prevent noise interference from the system.

To connect the transceiver and LC cable, please follow the steps shown below:

First, insert the transceiver into the SFP module. Notice that the triangle mark is the bottom of the module.

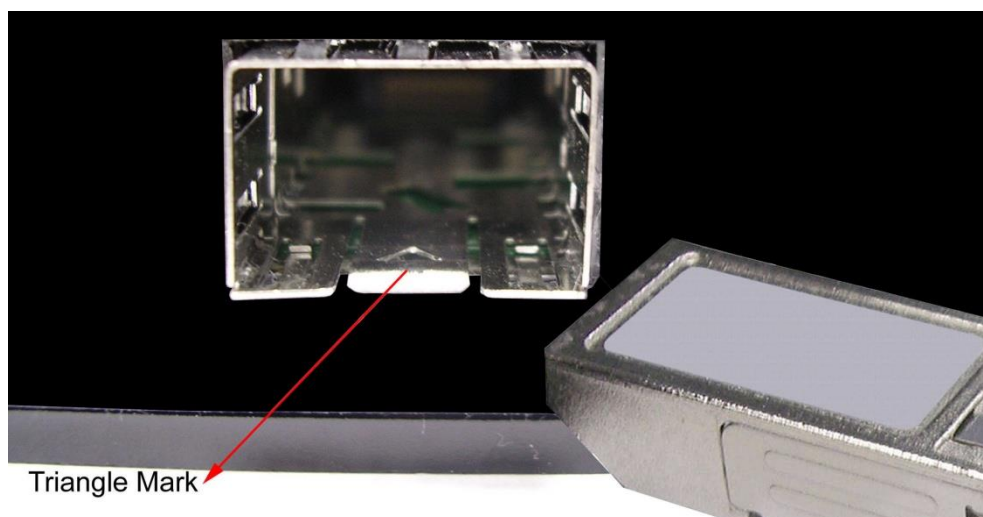

Transceiver to the SFP module



Transceiver Inserted

Second, insert the fiber cable of LC connector into the transceiver.

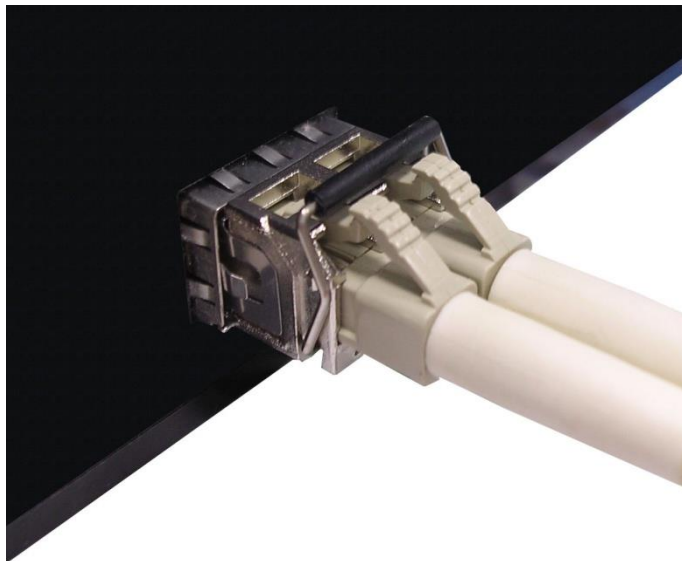

LC connector to the transceiver

To remove the LC connector from the transceiver, please follow the steps shown below:

First, press the upper side of the LC connector to release from the transceiver and pull it out.

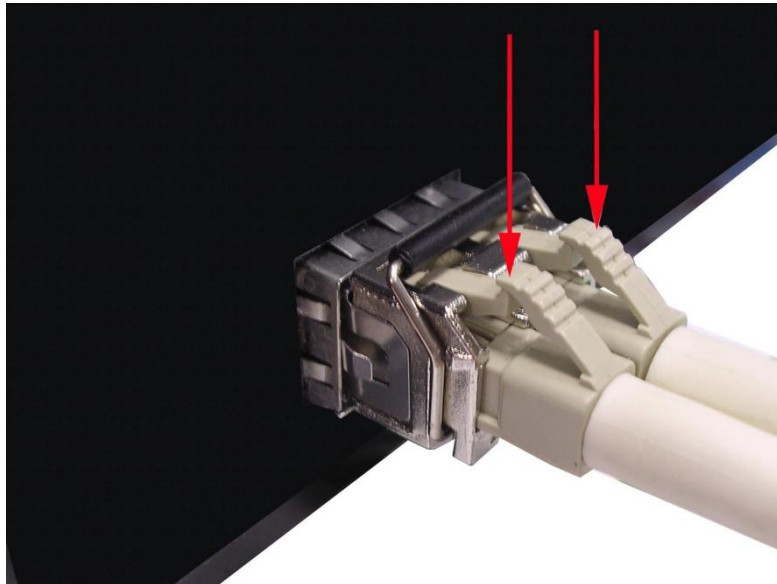

Remove LC connector

Second, push down the metal loop and pull the transceiver out by the plastic handle.

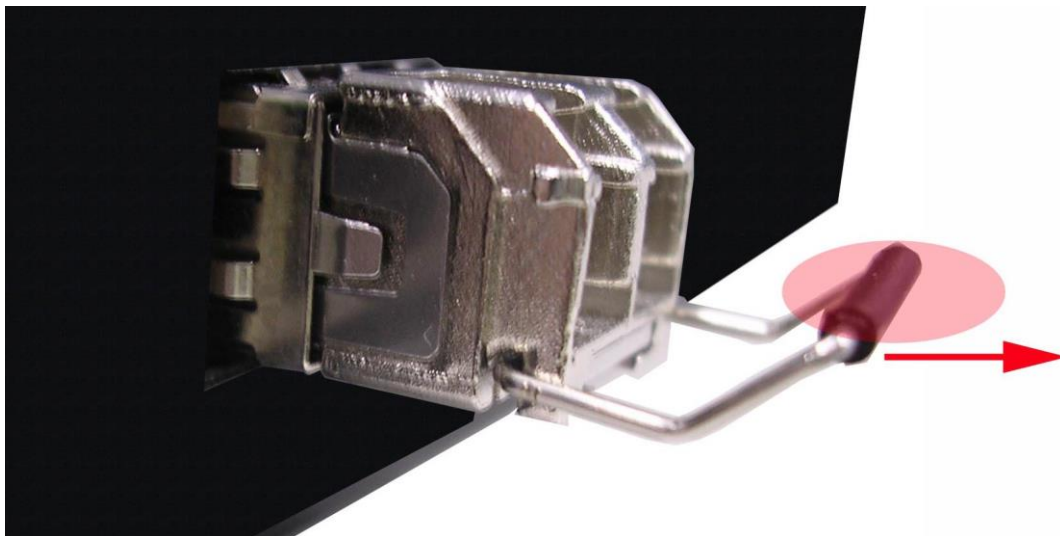

Pull out from the transceiver

Mounting Installation

DIN-Rail Mounting

Assembling the DIN-Rail Clip

The DIN-rail clip is screwed on the industrial switch when out of factory. If not, please refer to the following steps and figure to secure the DIN-rail clip on the switch.

- 1, Use the screws to screw on the DIN-rail clip on the industrial switch.
- 2, To remove the DIN-rail clip, reverse step 1.

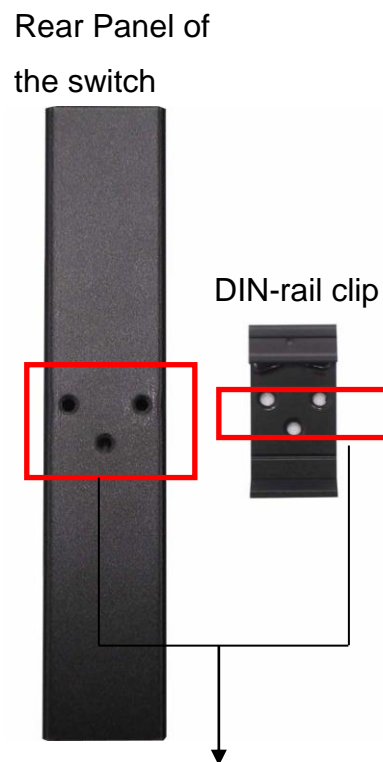

Hanging the Industrial Switch

Follow the steps below to hang the industrial switch on the DIN rail.

1, First, position the rear side of the switch directly in front of the DIN rail. Make sure the top of the clip hooks over the top of the DIN rail.

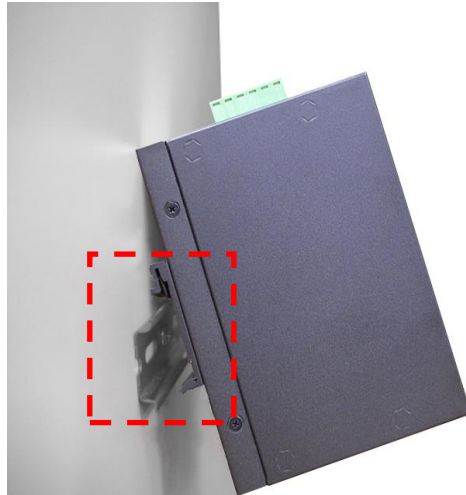

2, Push the unit downward.

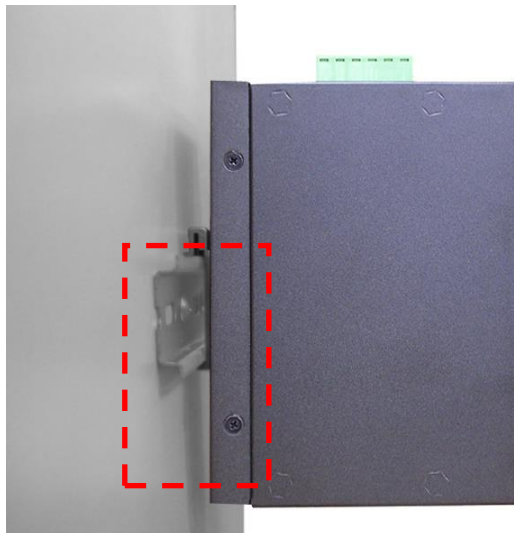

3, Check the DIN-Rail clip is tightly fixed on the DIN rail.

4, To remove the industrial switch from the track, reverse the steps above.

Wall-Mount Plate Mounting (Optional)

Follow the steps below to mount the industrial switch with the wall mount plates included.

1. To remove the DIN-Rail clip from the industrial switch, unscrew the screws to remove the DIN-Rail clip.



2. Place the wall-mount plates on the rear panel of the industrial switch.
3. Use the screws to secure the wall-mount plates on the industrial switch.

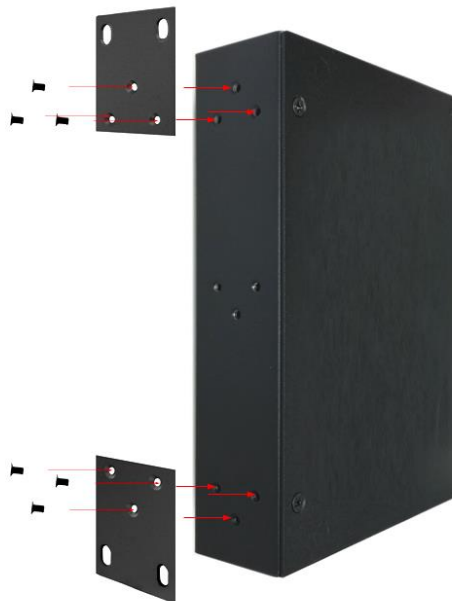

4. Use the hook holes at the corners of the wall-mount plates to hang the industrial switch on the wall.
5. To remove the wall-mount plates, reverse the steps above.

Hardware Installation

In this paragraph, we will describe how to install the Industrial Unmanaged Switch and the installation points for the attention.

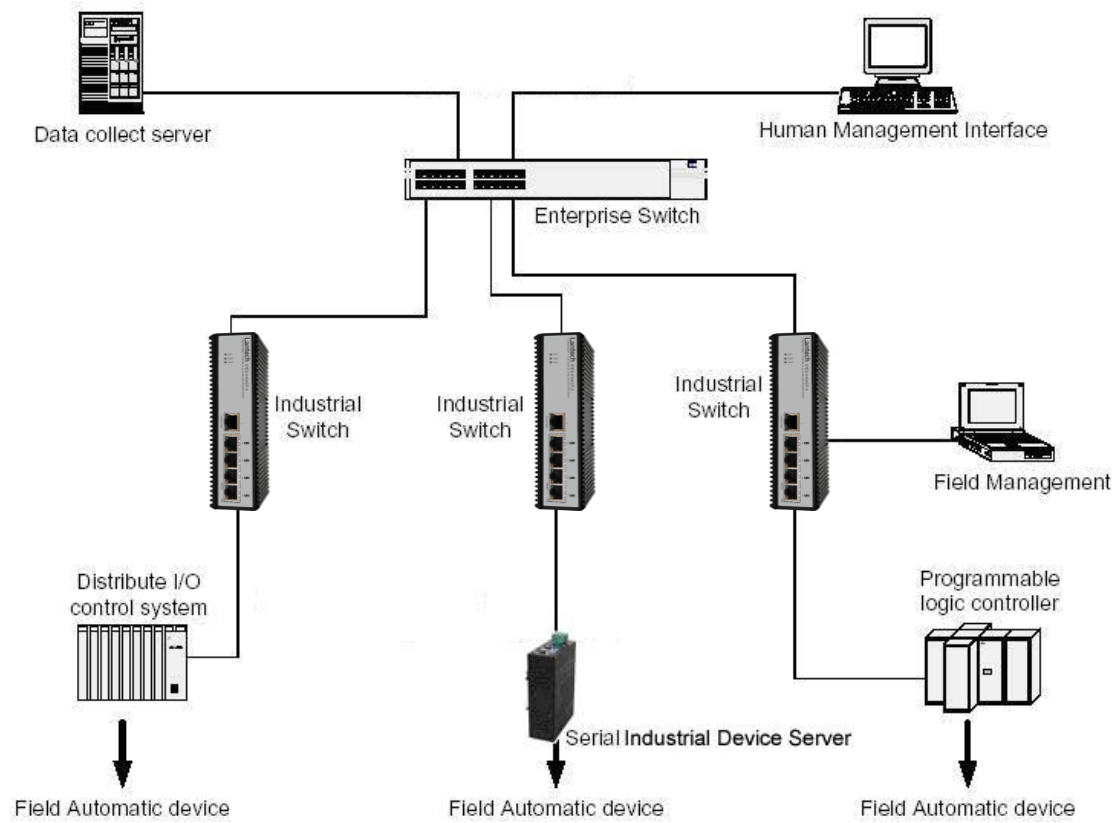

Installation Steps

1. Unpacked the Industrial switch.
2. Check the DIN-Rail is screwed on the Industrial switch. If the DIN-Rail is not screwed on the Industrial switch. Please refer to **DIN-Rail Mounting** section for DIN-Rail installation. If you want to wall mount the Industrial switch, then please refer to **Wall-Mount Plate Mounting** section for wall mount plate installation.
3. To hang the Industrial switch on the DIN-Rail track or wall, please refer to the **Mounting Installation** section.
4. Power on the Industrial switch. How to wire the power; please refer to the **Wiring the Power Inputs** section. The power LED on the Industrial switch will light up. Please refer to the **LED Indicators** section for meaning of LED lights.
5. Prepare the twisted-pair, straight through Category 5e cable for Ethernet connection.
6. Insert one side of Category 5e or above cable into the Industrial switch RJ-45 port and another side of category 5e or above cable to the network devices' RJ-45 port, ex: switch, PC or Server. The RJ-45 LED indicator on the Industrial switch will light up when the cable is connected with the network device. Please refer to the **LED Indicators** section for LED light meaning.
7. When all connections are all set and LED lights all show in normal, the installation is complete.

Troubleshooting

- Verify that you are using the included or appropriate power cord/adapter. Don't use the power adapter with DC output higher than the power rating of the device. Otherwise, the device will burn down.
- Select the proper UTP/STP cable to construct your network. Please check that you are using the right cable. Use unshielded twisted-pair (UTP) or shielded twisted-pair (STP) cable for RJ-45 connections: 100 Ω Category 3, 4 or 5 cable for 10Mbps connections, 100 Ω Category 5 cable for 100Mbps, or 100 Ω Category 5e/above cable for 1000Mbps connections. Also be sure that the length of any twisted-pair connection does not exceed 100 meters (328 feet).
- **Diagnosing LED Indicators:** The Switch can be easily monitored through panel indicators, which describes common problems you may encounter and where you can find possible solutions, to assist in identifying problems.
- IF the power indicator does not light on when the power cord is plugged in, you may have a problem with power cord. Then check for loose power connections, power losses or surges at power outlet. If you still cannot resolve the problem, contact your local dealer for assistance.
- If the Industrial switch LED indicators function normal and the connected cables are correct but the packets still cannot transmit, please check your system's Ethernet devices' configuration or status.