

IES-0208T (IP67/IP54)

8 10/100TX + 2 GigaT X-coded IP67/IP54 rated

EN50155 Ethernet Switch

- EN50155 verification / E-mark certified
- Provides M12 connector with IP67 or IP54 rated protection
- Wide Operating Temperature from -40°C to 75°C
- Wide range dual power inputs 9~60VDC with optional bypass protection for 1-pair GigaT ports
- 110V single power input 43~137.5V for 110V model



IP67 Rated



IP54 Rated

OVERVIEW

Lantech IES-0208T (IP67/IP54) is an 8 10/100TX + 2GigaT X-coded with M12-connector EN50155 unmanaged Ethernet switch for IP67 or IP54 rated protection, which meets the high reliability requirements demanded by industrial rolling stock applications.

The IES-0208T (IP67/IP54) is designed to meet with critical network environment with IP67/54 enclosure and M12 connectors for protection against dust and water. IP67 model can be immersed 1 meter under water for 30 minutes long, so it is the best to place in the highly damp and moisture area in the train, vehicle or rail-side. Both have passed harsh environmental testing to comply with Industrial EMI and Safety standards as well as stability testing such as Free fall, Shock, and Vibration. For a greater flexibility in application the IES-0208T (IP67/IP54) supports an extended operating

temperature range from -40°C to 75°C.

The wide range dual power input from 9V~60V fits with most of train/vehicle usage. The 110V model offers dual power supply that can be powered from 43~137.5VDC.

EN50155 for rolling stock, EN45545 fire and smoke verification

With EN45545-2 Fire & Smoke, EN50155 verification and certification, the IES-0208T (IP67/IP54) is best for railway and vehicle applications.

Optional GigaT bypass protection

The optional 1 pair bypass relay is set to bypass the switch to the next one when power is off in order to protect the network from crashing. Lantech bypass caters to remain in bypass mode until the switch is completely booting up when power is back to avoid another network lost.

FEATURES & BENEFITS

- 8 10/100TX+2GigaT X-coded EN50155 Unmanaged Ethernet Switch with M12 connectors and IP67/54 rated protection
- Dual Power Design with wide DC9~60V input
- 110V model support dual 43~137.5VDC power
- Back-plane (Switching Fabric): 3.6 Gbps
- 8K MAC address table
- Wide Operating Temperature (-40°C ~75°C)
- Din rail** and wall mount design
- EN45545-2 Fire & Smoke, EN50155 and EN61373 shock/vibration verification
- E-mark certified
- Bypass protection** - Bypass failed switch caused by power failure of switch to protect network intactness

DIMENSIONS (unit=mm)

IP67 model

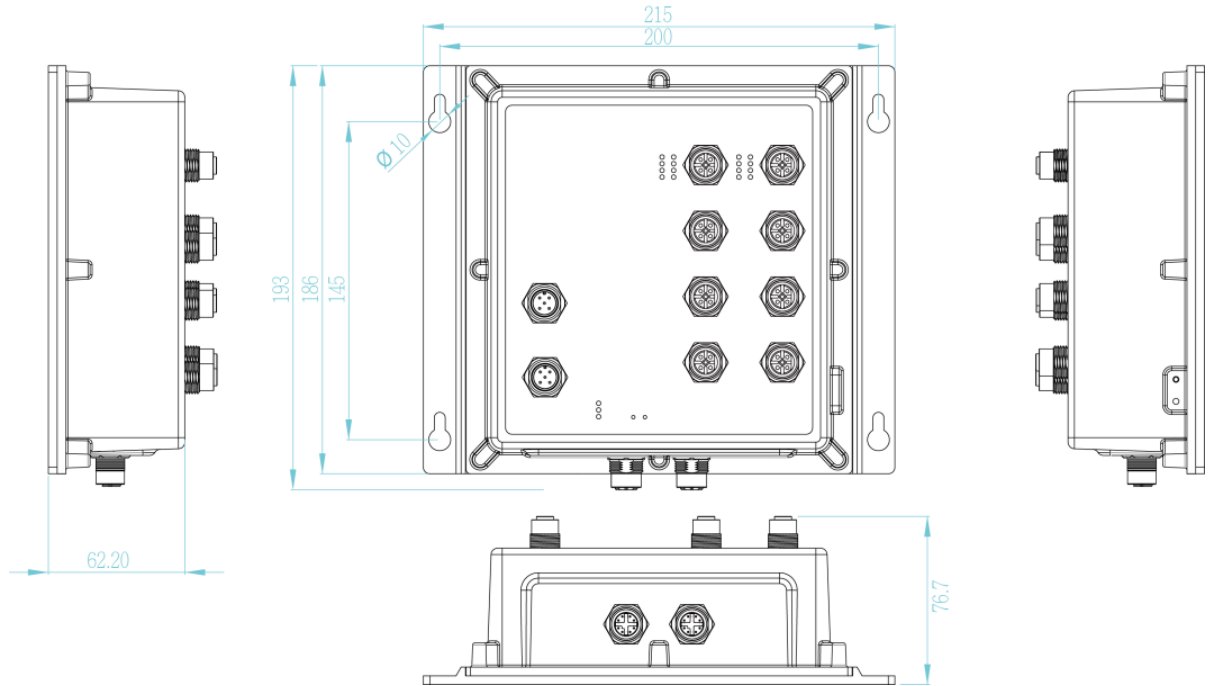

IP54 model

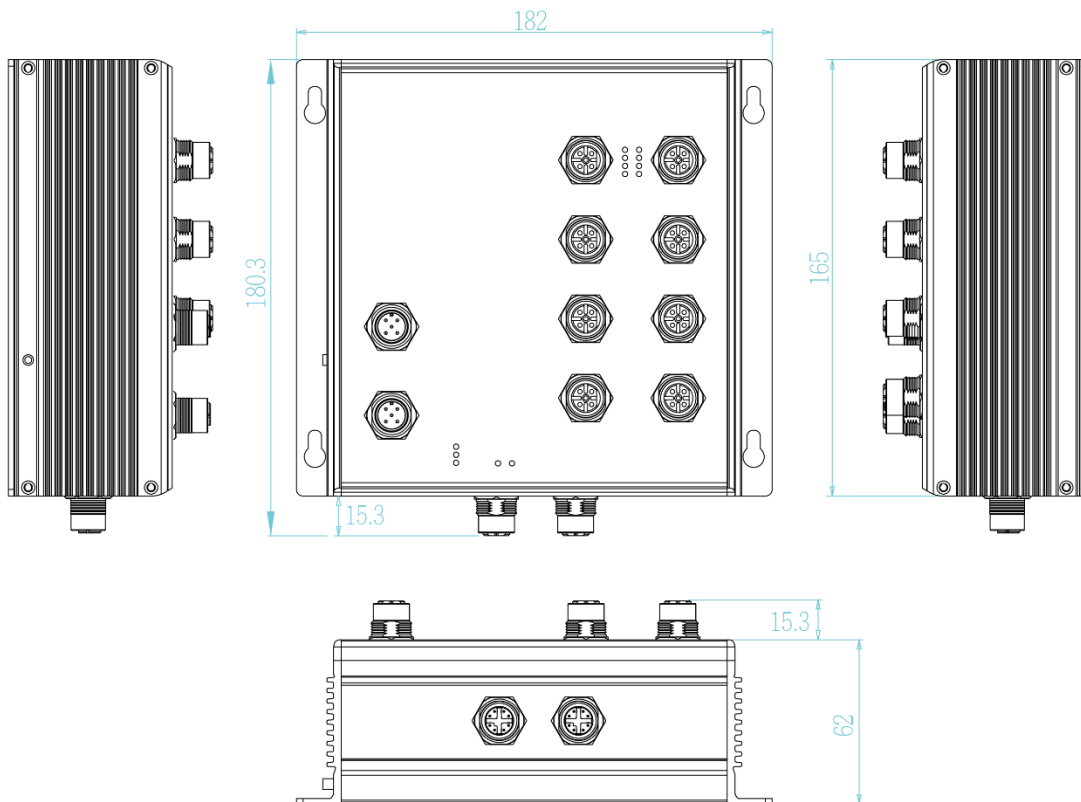

SPECIFICATION

Hardware Specification		Operating Temperature	-40°C ~ 75°C (-40°F ~ 167°F)
IEEE Standard	IEEE802.3 10BASE-T Ethernet IEEE802.3u 100BASE-T Ethernet IEEE802.3ab 1000BASE-T Ethernet IEEE802.3x Flow Control and Back Pressure	Storage Temperature	-40°C ~ 85°C (-40°F ~ 185°F)
Transfer Rate	14,880pps for Ethernet port 148,800pps for Fast Ethernet port 1,488,000pps for Gigabit Ethernet / Gigabit Fiber port	Dimensions	Aluminum case, IP-67, 215mm(W)x185mm(H)x71mm(D) Aluminum case, IP-54 182mm(W)x180.3mm(H)x77.3mm(D)
Mac Address	8K MAC address table	Weight	1.4kgs (IP67); 1.2kgs(IP54)
Connector	10/100T: 8 x M12, 4-pole D-coded, Female with auto MDI/MDI-X function 10/100/1000T: 2 x M12 8-pole X-coded with auto MDI/MDI-X function Power connector: 1 x M12, 5-pole A-coded, Male	Installation	Din Rail**, Wall Mount Design
Bypass Protection**	High-speed copper switching Support 1 pair Giga-T bypass	EMC	FCC Class A, CE EN61000-4-2 (ESD), CE EN61000-4-3 (RS), CE EN-61000-4-4 (EFT), CE EN61000-4-5 (Surge), CE EN61000-4-6 (CS), CE EN61000-4-8 (Magnetic Field), CE EN55022 Class A, CE EN55024
LED	Per unit: Power 1 (Green), Power 2 (Green), Ethernet: Link/Activity (Green) GigaT: Link/Activity (Green)	Stability Testing	EN61373 (Shock and Vibration)
Power Supply	9~60VDC on standard model 43~137.5VDC on 110V model	Verifications & report	EN50155/EN50121-3-2/EN50121-4 verification EN45545-2 R13/R22/R23/R24/R25 (EN ISO 4589-2, EN ISO 5659-2, NF X70-100-1 & 2) Fire & Smoke verification E-Mark E4 Certificate
Power Consumption	10W at 12/24/48V input 13.5W at 110V input	Warranty	5 years
Operating Humidity	5% to 95% (Non-condensing)		

*Pending
**Optional

ORDERING INFORMATION

All model packages include M12 caps and wall mount bracket. All standard models are non-coating, optional coating models are available with -C model name. Optional Bypass models are available with -BT model name,

- **IES-0208T-X-67.....P/N: 8360-5424**
8 10/100TX+2 GigaT X-coded EN50155 IP67 M12 Ethernet Switch; dual 9~60V input; -40~75C
- **IES-0208T-X-54.....P/N: 8360-5425**
8 10/100TX+2GigaT X-coded EN50155 IP54 M12 Ethernet Switch; dual 9~60V input; -40~75C
- **IES-0208T-X-67-110V.....P/N: 8360-5426**
8 10/100TX+2GigaT X-coded EN50155 IP67 M12 Ethernet Switch; dual 43~137.5VDC input; -40~75C
- **IES-0208T-X-54-110V.....P/N: 8360-5427**
8 10/100TX+2GigaT X-coded EN50155 IP54 M12 Ethernet Switch; dual 43~137.5VDC input; -40~75C

OPTIONAL ACCESSORIES

M12/M23 Connector & Cable

- **ECONM12-05A(F)-C-180** M12 5Pin (Female) A-coded 180 Degree Crimp Type Connector
- **ECONM12-5P(F)70CM CABLE** 5 Pin M12 Power Female 90C angle Connector+ 70 CM Cable
- **ECAB124030MJS** 4 Pin M12 RJ45 Male 3 Meters; STP Cable

Lantech Communications Global Inc.

www.lantechcom.tw
info@lantechcom.tw

© 2019 Copyright Lantech Communications Global Inc. all rights reserved.
The revise authority rights of product specifications belong to Lantech Communications Global Inc.
Lantech may make changes to specification and product descriptions at anytime, without notice.