

Lantech

IPES-0208CA-12V

8 10/100TX + 2 10/100/1000T/Dual Speed SFP Combo w/
8x12V/24V/48V PoE at/af Injector Industrial Switch

User Manual

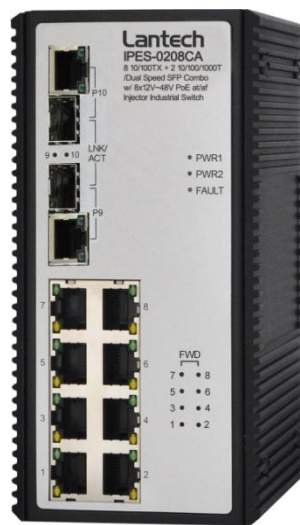

V1.10
Aug 2017

FCC Warning

This Equipment has been tested and found to comply with the limits for a Class-A digital device, pursuant to Part 15 of the FCC rules. These limits are designed to provide reasonable protection against harmful interference in a residential installation. This equipment generates, uses, and can radiate radio frequency energy. It may cause harmful interference to radio communications if the equipment is not installed and used in accordance with the instructions. However, there is no guarantee that interference will not occur in a particular installation. If this equipment does cause harmful interference to radio or television reception, which can be determined by turning the equipment off and on, the user is encouraged to try to correct the interference by one or more of the following measures:

- Reorient or relocate the receiving antenna.
- Increase the separation between the equipment and receiver.
- Connect the equipment into an outlet on a circuit different from that to which the receiver is connected.
- Consult the dealer or an experienced radio/TV technician for help.

CE Mark Warning

This is a Class-A product. In a domestic environment this product may cause radio interference in which case the user may be required to take adequate measures.

Content

Introduction	1
Features.....	1
Technical Specification.....	3
Package Contents.....	6
Safety Precaution.....	6
Hardware Description	7
Physical Dimension.....	7
Front Panel.....	8
Top View.....	9
LED Indicators.....	9
Ports.....	10
Cabling.....	11
Wiring the Power Inputs	12
Wiring the Fault Alarm Contact.....	14
Mounting Installation	15
DIN-Rail Mounting.....	15
Wall Mounting.....	16
Hardware Installation	18
Installation Steps.....	18
Network Application	19
Troubleshooting	20

Introduction

IPES-0208CA-12V Industrial Switch is a cost-effective solution, which meets the high reliability requirements demanded by industrial applications, and also supports to operate in the wide temperature $-40^{\circ}\text{C} \sim 75^{\circ}\text{C}$ environments(-E model). Besides, the equipment supports **12V/24V/48V DC power input** and provides the **PoE function with 48VDC output** for any kinds of powered devices to receive power as well as data over an RJ-45 cable.

Features

- System Interface/Performance
 - RJ-45 port support Auto MDI/MDI-X Function
 - Embedded 8-port booster PoE injector function
 - SFP (Mini-GBIC) supports 100/1000 Dual Mode
 - IEEE 802.3af/at Standards
 - Back-plane (Switching Fabric): 5.6Gbps
 - 1Mbits Packet Buffer
 - 8K MAC Address Table
 - Support Operating Temperature ($-20^{\circ}\text{C}\sim 60^{\circ}\text{C}$)/ ($-40^{\circ}\text{C}\sim 75^{\circ}\text{C}$)-E models
 - DC 12V/24V/48V Redundant Power Input
- Operating Temperature
 - Standard Temperature: $-20^{\circ}\text{C}\sim 60^{\circ}\text{C}$
 - Extended Temperature: $-40^{\circ}\text{C}\sim 75^{\circ}\text{C}$
- Case/Installation
 - IP-30 Protection
 - Installation in a Pollution Degree 2 environment
 - DIN Rail and Wall Mount** Design
- Provides EFT protection 3,000 VDC for power line
- Supports 6,000 VDC Ethernet ESD protection

Technical Specification

The technical specifications of IPES-0208CA-12V Industrial Switch are listed as follows.

Communications

Compatibility	IEEE 802.3, 802.3u, 802.3ab 802.3z, 802.3x, 802.3af/at
LAN	10/100Base-T
Switch Architecture	Back-plane (Switching Fabric): 5.6Gbps Packet throughput ability(Full-Duplex): 8.3Mpps @64bytes

Interface

Connectors	10/100TX: 8 x RJ-45 10/100/1000T/ Mini-GBIC Combo: 2 x RJ-45 + 2 x 100/1000 SFP sockets
LED Indicators	Unit: Power1, Power2, P-Fail, PoE Ethernet port: Link/Active, Speed

PoE

Power Output	Per port 48 V _{DC} , 15.4 Watts(802.3af)/30Watts(at)
Pin Assignment	RJ-45 port #1 ~ # 8 support IEEE 802.3af/at End-point, Alternative A mode. Positive (VCC+): RJ-45 pin 1, 2. Negative (VCC-): RJ-45 pin 3, 6. Data (1,2,3,6)

Power

Power Consumption	10 Watts (Max.); POE Power Budget:240 Watts (48V input); 120W(24V input); 90W(12V)
--------------------------	--

Power Input External Power Supply: DC 9~56V, Redundant power D9V~DC 56V and connective removable terminal block

Fault Output 1 Relay Output

Mechanism

Dimensions (WxHxD) 74mm (W) x 114mm (D) x 152mm (H)

Enclosure IP-30, Metal shell with solid mounting kits

Mounting DIN Rail and Wall Mount** Design

Protection

ESD (Ethernet) 6,000 V_{DC}

Surge (EFT for power) 3,000 V_{DC}

Power Reverse Yes

Overload current protection Yes

Environment

Operating Temperature Standard: -20°C~60°C /-4°F~140°F

Extended:- 40°C~75°C /-40°F~167°F

Operating Humidity 5% ~ 95% (non-condensing)

Storage Temperature -40 ~ 85°C

Storage Humidity 5% ~ 95% (non-condensing)

Certifications

EMC FCC Class A, CE EN55032 Class A, CE EN61000-4-2 (ESD), CE EN61000-4-3 (RS), CE EN-61000-4-4 (EFT), CE EN61000-4-5 (Surge), CE EN61000-4-6 (CS), CE EN61000-4-8, CE EN61000-4-11, CE EN61000-4-12, CE EN61000-6-2, CE EN61000-6-4

Free Fall

IEC60068-2-32

Shock

IEC60068-2-27

Vibration

IEC60068-2-6

Package Contents

Please refer to the package contents list below to verify them against the checklist.

- IPES-0208CA-12V Industrial Switch (with DIN-Rail Bracket)
- User manual
- Removable Terminal Block
- Optional Wall-mount Kit** (2 wall-mount bracket with screws)

Compare the contents of the industrial switch with the standard checklist above. If any item is damaged or missing, please contact the local dealer for service.

Safety Precaution

Attention *IF DC voltage is supplied by an external circuit, please use a protection device on the power supply input.*

Hardware Description

In this paragraph, the Industrial switch's hardware specs, ports, cabling information, and wiring installation will be described.

Physical Dimension

IPES-0208CA-12V Industrial Switch dimensions (W x D x H) is 74mm x 114mm x 152mm, the detail dimensions as **Figure-1**

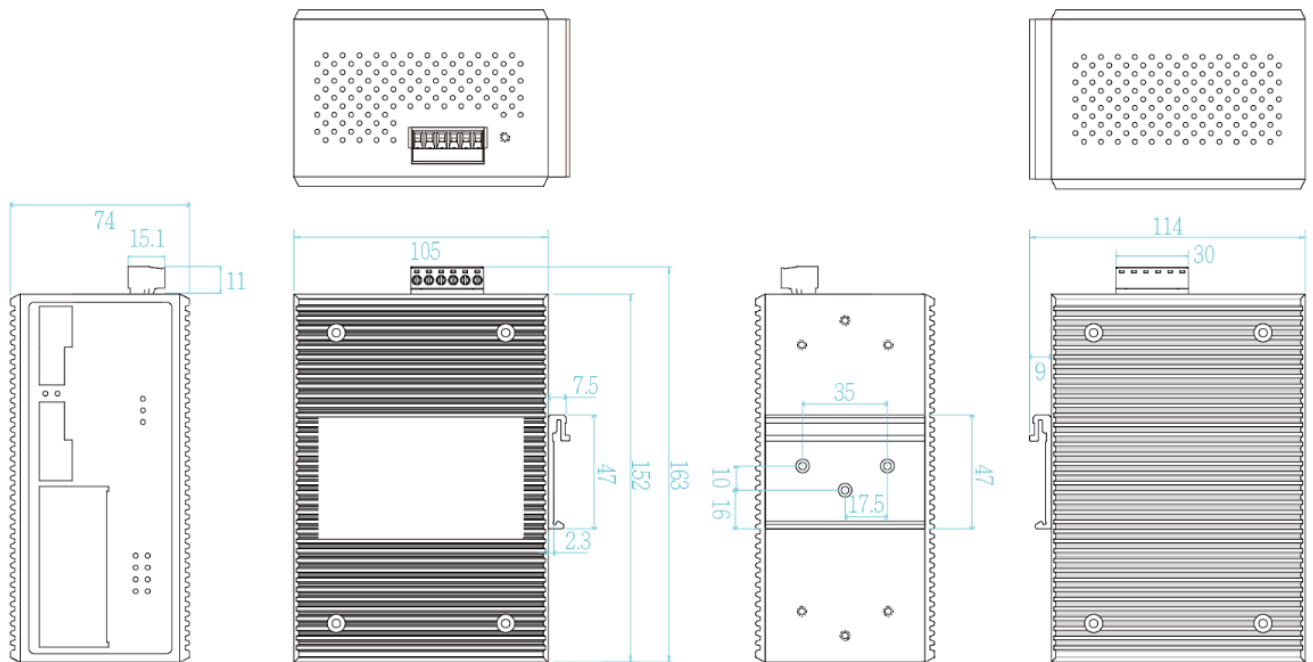

Figure-1: Mechanical Dimensions

Front Panel

The Front Panel of IPES-0208CA-12V Industrial Switch is shown below **Figure-2**

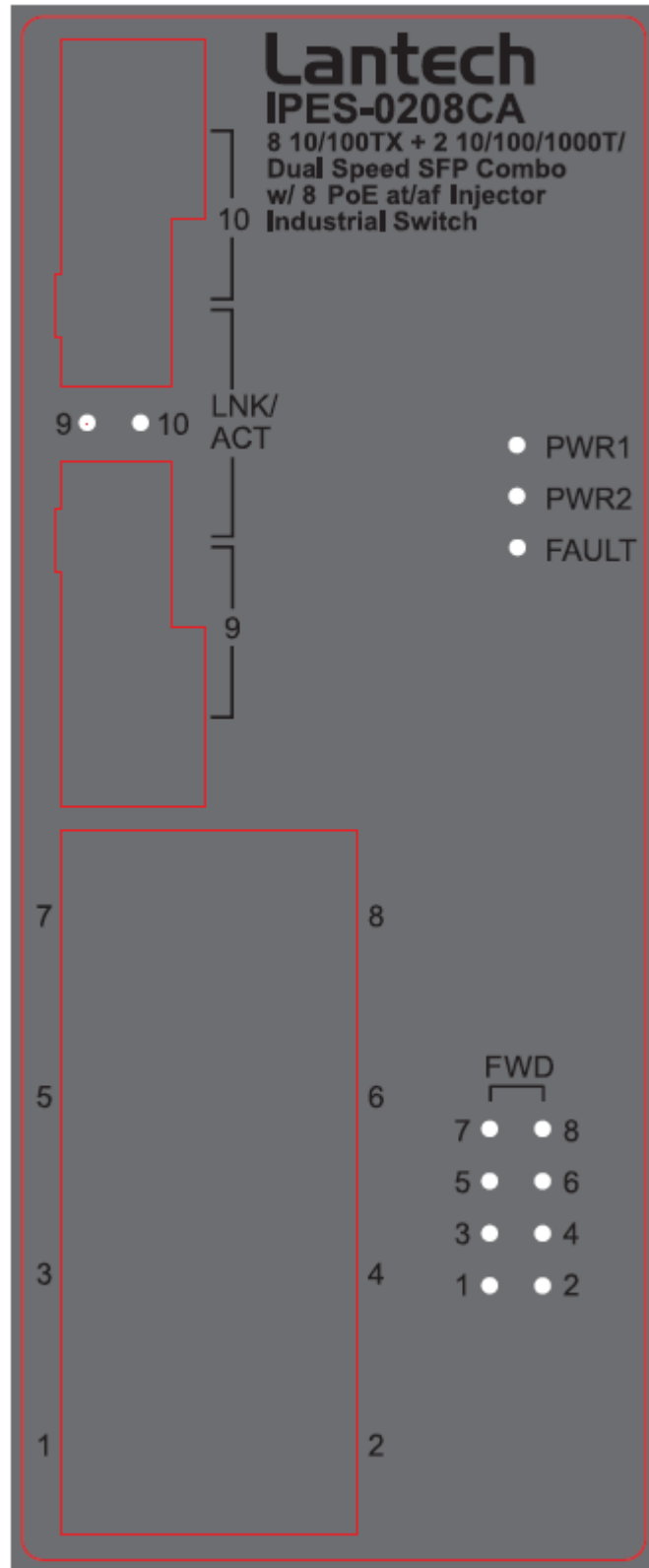

Figure-2: Front Panel of the PoE Injectors Industrial Switch

Top View

The top view of IPES-0208CA-12V Industrial Switch has one terminal block connector of two DC power inputs and Relay circuit contact. Please refer to **Figure-3** for further information.



Figure-3: Top View of the PoE Injectors Industrial Switch

LED Indicators

The diagnostic LEDs located on the front panel of the industrial switch provide real-time information of system and operation status. **Table-1** provides the description of the LEDs status and their definitions for the switch.

LED	Color	Description	
P1	Green	On	Power input 1 is active
		Off	Power input 1 is inactive
P2	Green	On	Power input 2 is active
		Off	Power input 2 is inactive
P-Fail	Red	On	Power input 1 or 2 has failed
		Off	Power input 1 and 2 are both functional, or no power inputs
PoE indicator (Port 1 ~ 8)	Green	On	The port is supplying power to the powered-device
		Off	No powered-device attached or power supplying fails
LAN Port 1 ~ 8	Green	On	Connected to network



(RJ-45)		Flashing	Networking is active	
		Off	Not connected to network	
	Green		On	Connected to network at speed of 100Mbps
			Off	Connected to network at speed of 10Mbps or not connected to network

Table-1: LED Indication Definition

Ports

■ RJ-45 ports

The Fast Ethernet ports (RJ-45) will auto-sense for 10Base-T or 100Base-TX connections. Auto MDI/MDI-X means that the switch can connect to another switch or workstation without changing straight-through or crossover cabling. Please refer to **Table-2** for RJ-45 pin assignment.

Pin Number	Assignment
1	Tx+
2	Tx-
3	Rx+
6	Rx-

Table-2: RJ-45 Pin Assignment

Note “+” and “-” signs represent the polarity of the wires that make up each wire pair.

All ports on this industrial switch supports automatic MDI/MDI-X operation, users can use straight-through cables (See figures below) for all network connections to PCs or Servers, or to other switches/hubs. In straight-through cable, pins 1, 2, 3, and 6, at one end of the cable, are connected straight through to pins 1, 2, 3 and 6 at the other end of the cable. **Table-3** shows the 10BASE-T/100BASE-TX MDI and MDI-X port pin-outs.

Pin	MDI-X Signal	MDI Signal
1	Receive Data plus (RD+)	Transmit Data plus (TD+)
2	Receive Data minus (RD-)	Transmit Data minus (TD-)
3	Transmit Data plus (TD+)	Receive Data plus (RD+)
6	Transmit Data minus (TD-)	Receive Data minus (RD-)

Table-3: MDI/MDI-X Port Pin-outs

The following figures show the cable schematic for straight-through type (**Figure-4**) and crossover type (**Figure-5**).

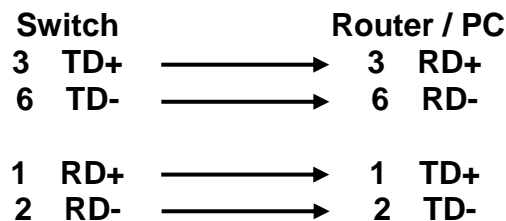

Figure-4: Straight Through Cable Schematic

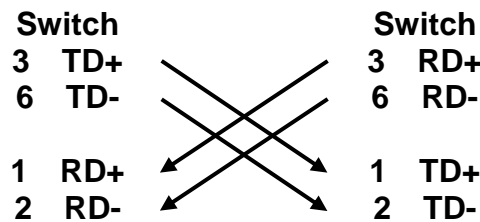

Figure-5: Crossover Cable Schematic

Cabling

- Twisted-pair segments can be connected with unshielded twisted pair (UTP) or shielded twisted pair (STP) cable. The cable must comply with the IEEE 802.3u 100Base TX standard (e.g. **CAT.5**, **CAT.5e**, or **CAT.6**). The cable between the equipment and the link partner (switch, hub, workstation, etc.) must be less than 100 meters (328 ft.) long.

Wiring the Power Inputs

Please follow the steps below to wire the power cord which from the other compliant external DC power supplier.

1. Insert the positive and negative wires into the **PWR1 (V+, V-)** and **PWR2 (V+, V-)** contacts on the terminal block connector as shown in **Figure-6**.

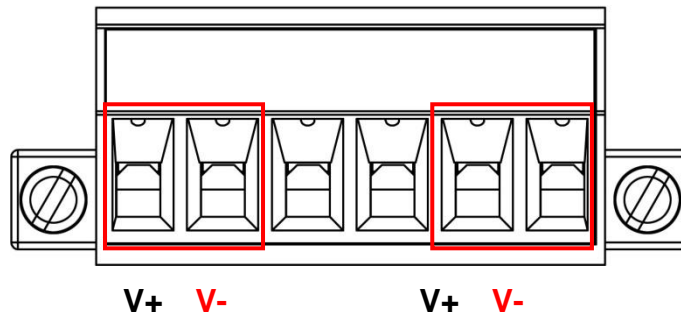

Figure-6: Terminal Block Front View for Power1 & Power2 Contact

2. Tighten the wire-clamp screws which as shown in the **Figure-7** for preventing the wires from loosing.

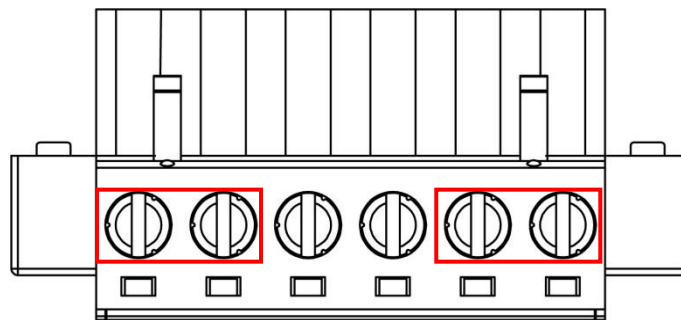
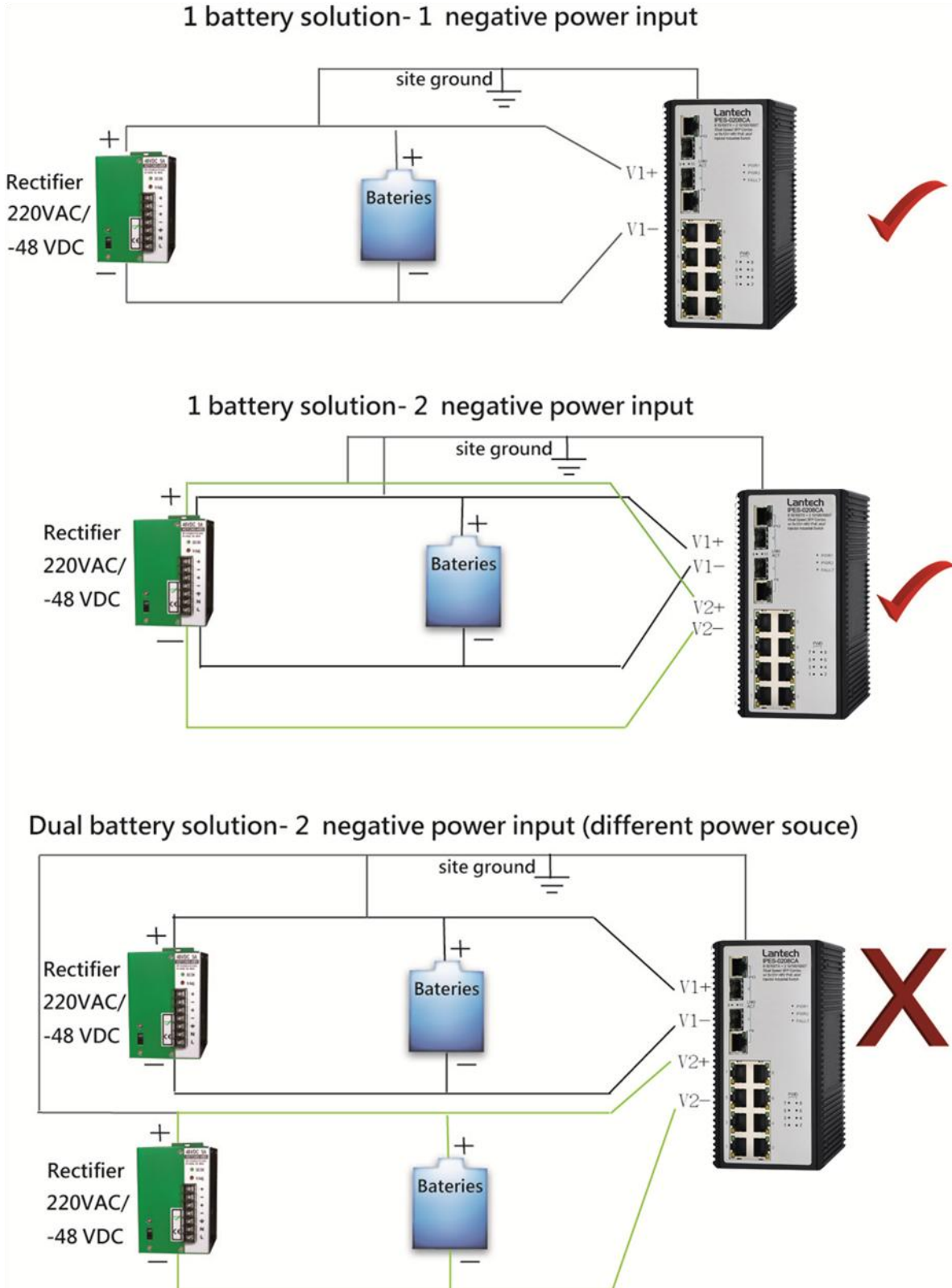

Figure-7: Terminal Block Top View

- Note**
- Use Copper Conductors Only, **60/75°C**, Tighten to **5 lb in**
 - The wire gauge for the terminal block should be in the range between **12~ 24 AWG**.

Power Restriction (under - 48VDC power)

IPES-0208CA-12V only can support one -48VDC power source. If using two -48VDC power source, IPES-0208CA-12V may cause damage.



Wiring the Fault Alarm Contact

The fault alarm contact is in the middle of terminal block connector as the picture shows below. Inserting the wires, will detect the fault status including power failure or *port link failure (managed industrial switch only)* and from a **Normally Close** circuit. Please refer to **Figure-8** for the fault alarm contact, and **Figure-9** shows the application example for the fault alarm operation.

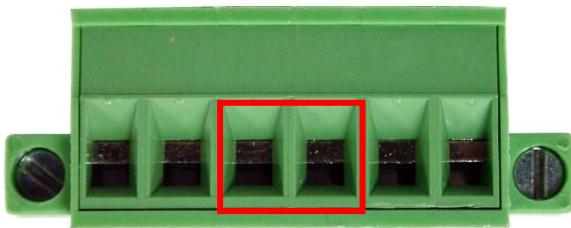

Figure-8:

Terminal Block Front View for Fault Alarm Contact

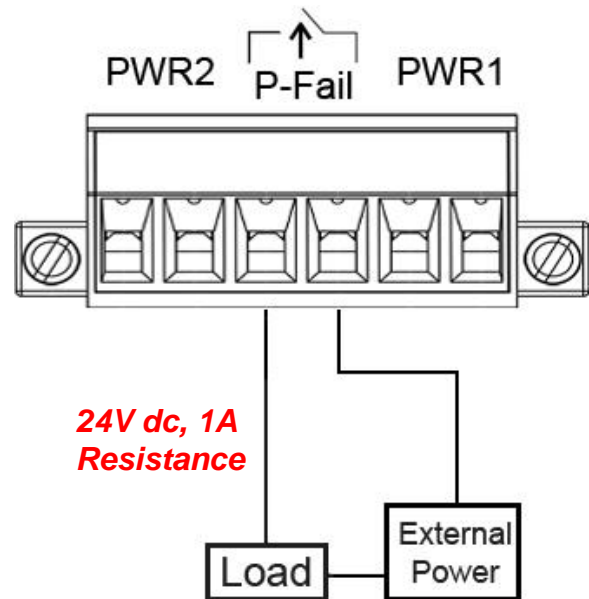

Figure-9:

Fault Alarm Application Example

- Note**
- Use Copper Conductors Only, **60/75°C**, Tighten to **5 lb in**
 - The wire gauge for the terminal block should be in the range between **12~ 24 AWG**.

Mounting Installation

DIN-Rail Mounting

The DIN-Rail bracket is screwed on the switch on the production line in the factory. If the bracket is not screwed on the switch, please refer to **Figure-10** to screw it on the switch. Follow the steps below to hang the industrial switch.

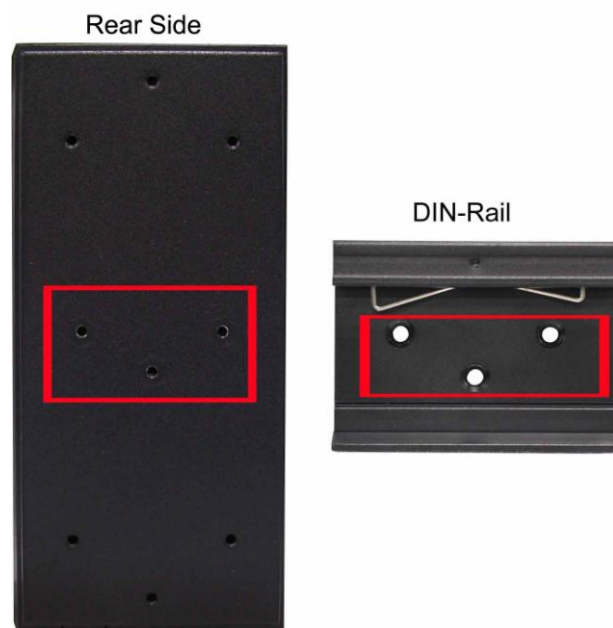

Figure-10: Rear side of the PoE Injectors Industrial Switch

1. Use the screws to screw the DIN-Rail bracket on the rear side of the industrial switch.
2. To remove the bracket, reverse the step 1.
3. After the DIN-Rail bracket is screwed on the rear side of the switch, insert the top of the bracket into the rail as **Figure-11**.

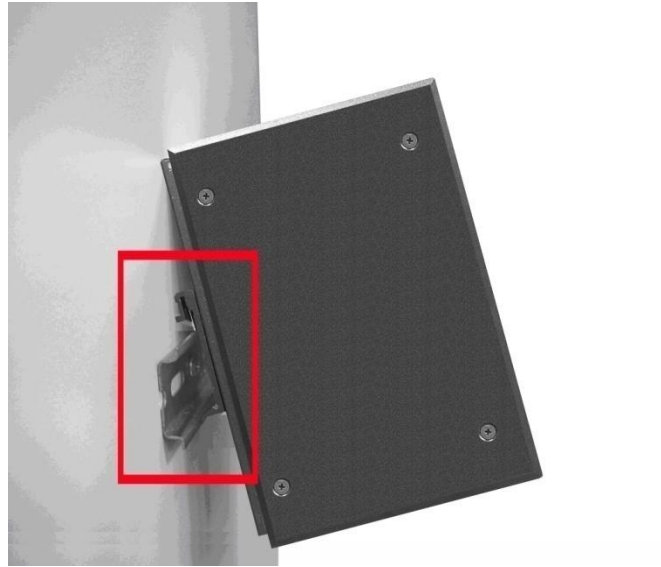

Figure-11

4. Then, lightly pull-down the bracket into the rail as shown in **Figure-12**.

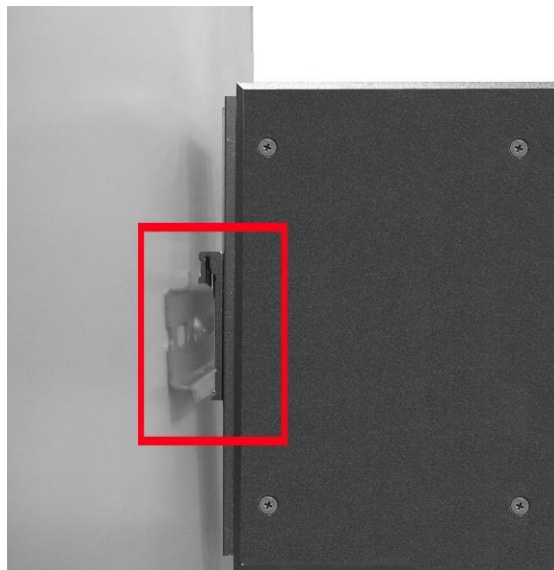

Figure-12

5. Check if the bracket is tightened on the rail or not.
6. To remove the switch from the rail, reverse steps above.

Wall Mounting(optional)**

Please refer to **Figure-13** and follow the steps below to mount the industrial switch with

wall-mount bracket, and the detail dimension of the bracket as **Figure-14**.

1. Remove the DIN-Rail bracket from the switch; loose the screws to remove it.
2. Place the wall-mount bracket on the top side and bottom side of the switch.
3. Use the screws to screw the wall-mount bracket on the switch.
4. Use the hook holes at the corners of the wall-mount bracket to hang the industrial switch on the wall.
5. To remove the wall-mount bracket, reverse steps above.

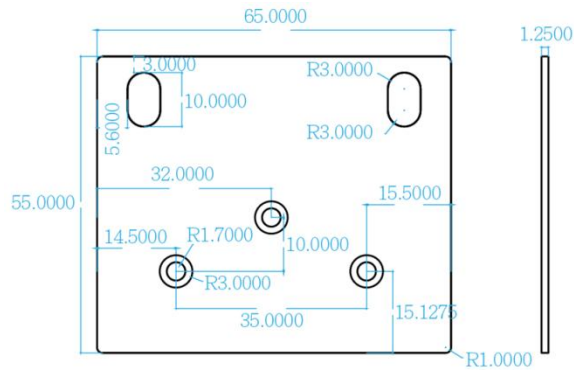

NOTE : Wall mount kits are optional accessories

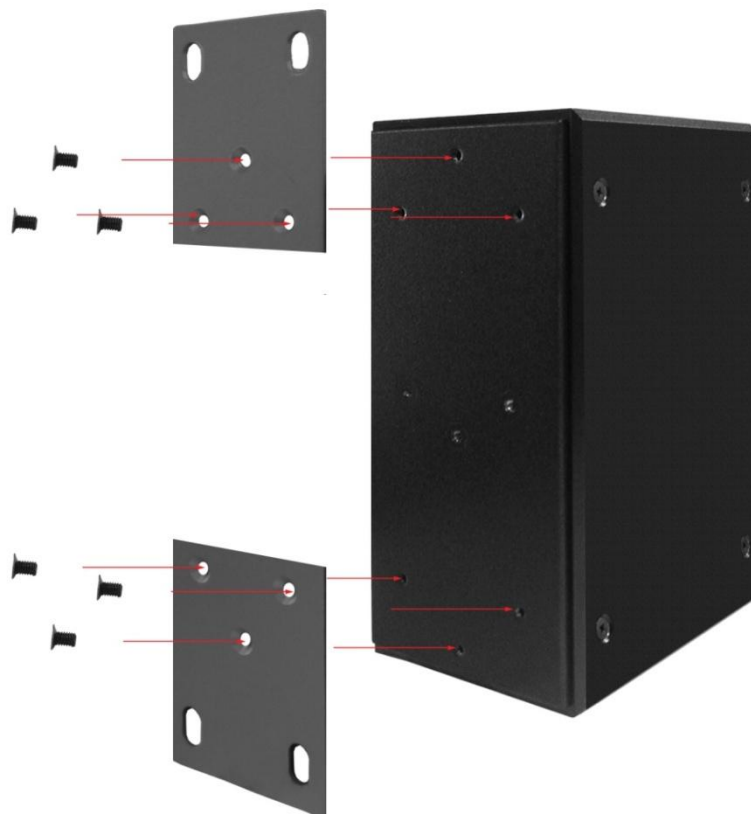

Hardware Installation

In this paragraph, we are going to explain how to install IPES-0208CA-12V Industrial Switch and the installation points to be attended to it.

Installation Steps

1. Unpack the Industrial switch packing.
2. Check if the DIN-Rail bracket is screwed on the Industrial switch or not. If the bracket is not screwed on the Industrial switch, please refer to **DIN-Rail Mounting** section for DIN-Rail installation. If the user wants to mount the Industrial switch on the wall, then please refer to **Wall Mounting** section for wall mount plate installation.
3. To hang the Industrial switch on the DIN-Rail or wall, please refer to the **Mounting Installation** section.
4. Power on the Industrial switch. Please refer to the **Wiring the Power Inputs** section for knowing the information about how to wire the power cord. The power LED on the Industrial switch will light up. Please refer to the **LED Indicators** section for indication of LED lights.
5. Prepare the twisted-pair, straight through CAT.5/above cable for Ethernet connection.
6. Insert one side of the RJ-45 cable into the Industrial switch Ethernet port and another side to the network device's Ethernet port, e.g. Switch, PC or Server. The Ethernet port (RJ-45) LED on the Industrial switch will light up when the cable is connected with the network device. Please refer to the **LED Indicators** section for LED light indication.
7. When all connections are set and LED lights all show in normal, the installation is complete.

Network Application

This segment provides the sample to help user have more actual idea of industrial switch application. For a sample application of the industrial switch, see the **Figure-15** below.

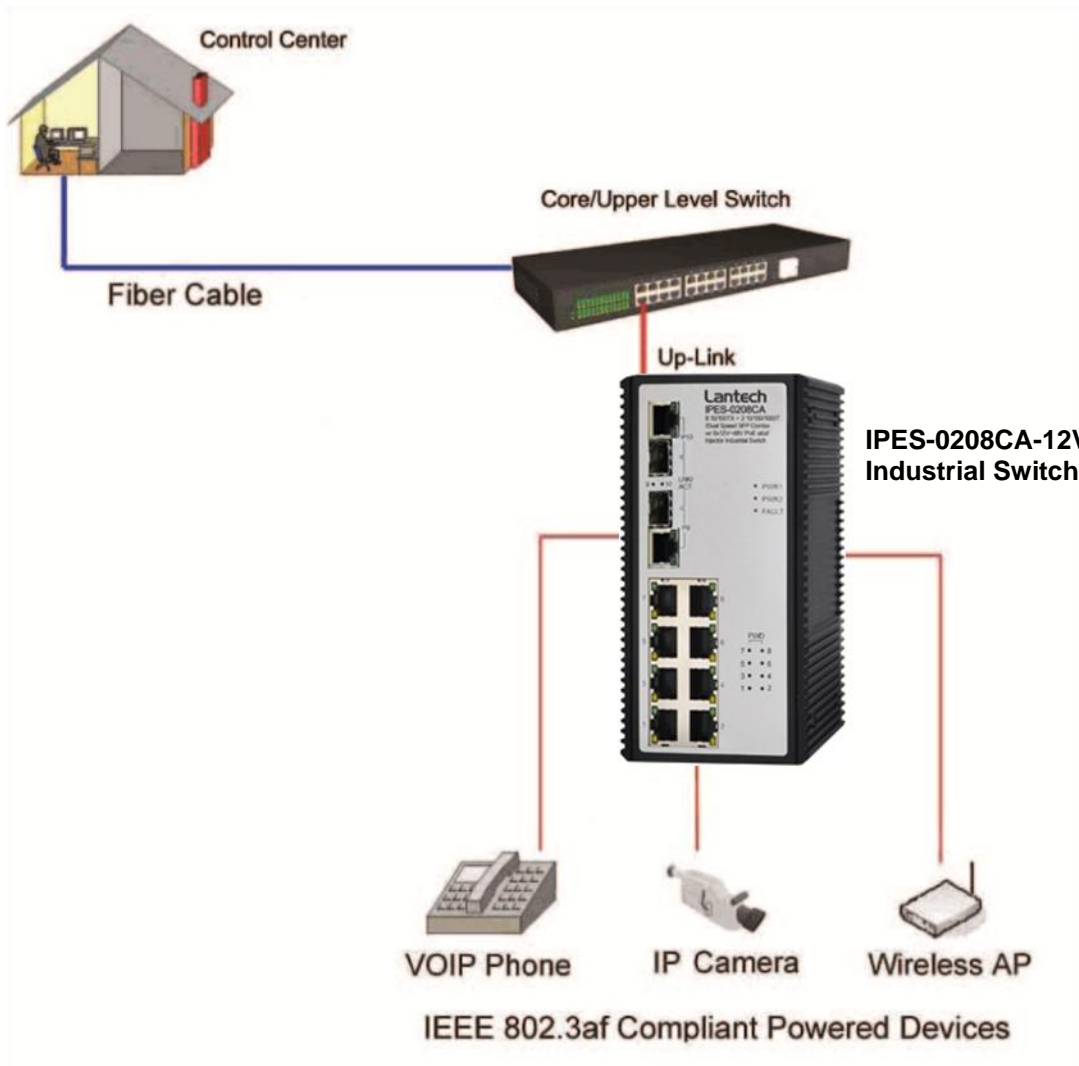

Figure-15: Network Application

Troubleshooting

- Verify that you are using the right power cord/supplier/adapter (**DC 12V/48V**), please don't use the power supplier/adapter with a non-compliant DC output voltage, or it will burn the equipment.
- Select the proper UTP/STP cable to construct your network. Please check that you are using the right cable. Use unshielded twisted-pair (UTP) or shield twisted-pair (STP) cable for RJ-45 connections: 100Ω Category 3, 4 or 5 cable for 10Mbps connections, 100Ω Category 5 cable for 100Mbps connections, or 100Ω Category 5e/above cable for 1000Mbps. Also be sure that the length of any twisted-pair connection does not exceed 100 meters (328 feet).
- **Diagnosing LED Indicators:** To assist in identifying problems, the Switch can be easily monitored through LED indicators on the front panel, which describe common problems the user may encounter and where the user can find possible solutions.
- If the power indicator does not light on when the power cord is plugged in, user may have a problem with the power cord. Then check for loose power connections, power losses or surges at power outlet. If you still cannot resolve the problem, contact the local dealer for assistance.
- If the Industrial switch LED indicators are normal and the connected cables are correct but the packets still cannot transmit. Please check your system's Ethernet devices' configuration or status.